

ROYAL ENFIELD OWNER'S MANUAL

GUERRILLA
450

BS VI

Customer Support

1800 - 210 - 0008

1. Product Update
2. Feedback
3. Dealer Locator

Roadside Assistance (RSA)

1800 - 210 - 0007

 @royalenfield |  www.royalenfield.com |  Support@royalenfield.com

Download the ROYAL ENFIELD APP and explore more



To access dealer details scan the QR code



FOREWORD

Welcome to the Guerrilla 450, a fiercely unique roadster that will revolutionize the way you ride.

Fueling it is the all-new, liquid-cooled Sherpa 450 engine, which has been specially tuned to deliver torque and power across the rev range for fully usable real-world power. The suspension has been developed to enhance every kind of riding style, every day of the week. The Guerrilla 450 also comes equipped with ergonomics that evolve with your riding style and enable you to handle everything from traffic to twisties.

This Owner's Manual has been designed to help you operate and maintain your Guerrilla 450 the right way, allowing you to get the most out of your motorcycle. To ensure your Guerrilla 450 always gets the best care, please avail the services of your nearest Royal Enfield Authorized Service Centre. Do read through the terms and conditions of warranty and other useful information given in this manual before you head out.

NOTICE

All information in this manual is based on the latest product information available at the time of publication. Due to continuous improvements, there may be differences between the information provided in this manual and information related to your motorcycle.

Always consult an authorized Royal Enfield dealer for the latest specifications, features etc. Royal Enfield reserves the right to make production changes at any time without prior notice and without incurring any obligation to make the same or similar changes to a motorcycle previously built or sold. All images shown are for reference to explain and need not to be exactly the same on the model you own. Accessories and features may not be part of standard equipment. Technical specifications are subject to change without prior notice at the sole discretion of Royal Enfield.

Please take care while disassembling and assembling the seats, and sheet metal parts, as any sharp edges will lead to injuries.

“© Copyright 2024 Royal Enfield (A unit of Eicher Motors Ltd.). All Rights Reserved. No part of this manual shall be copied, distributed or otherwise dealt without the express permission in writing from Royal Enfield”.

DISCLAIMER

1. Do not polish matt finished paint surface in your motorcycle as it will increase the gloss level.
2. Wash the painted parts only with plain water and do not use any strong solvents cleaning agents or detergents.
3. Scratches, if happens on the matt finish parts cannot be touched up and corrected / removed.
4. Warranty is not applicable for any matt finished painted parts of the motorcycle.

NOTE

■ This motorcycle meets the BS VI emission norms. Part No. RAM00971/A / 16th July 2024 /

CONTENTS

Safety definitions	4	Parking	77
Personal and motorcycle information.....	5	Tools kit and first aid kit	79
Safe riding tips / guidelines	6	Minor maintenance tips	80
Rules of the road	10	Long trip precautions	114
Accessories and luggage	12	Rear suspension setting	115
Technical specifications	14	Cleaning procedure	117
Recommended lubricants	19	Storage precautions	119
Motorcycle identification numbers	20	Troubleshooting.....	120
Location of key parts.....	21	Environment care.....	122
Operation of controls	24	Periodical maintenance.....	123
Warning indications and safety systems	64	Warranty terms and conditions.....	128
Pre-operational checks	68	Emission warranty.....	131
Running in period	69	Evaporative emission control system warranty.....	136
Starting.....	70	Service / Maintenance record	137
Gear shifting, riding and stopping.....	74	Notes	138

SAFETY DEFINITIONS

The information given under the titles: Warning, Caution and Note are for your safety and for the care and safety to your motorcycle and others. Please read these carefully and if disregarded may result in injury to yourself or others and damages to the motorcycle.



WARNING

Indicates a potentially hazardous situation. Disregarding this message may result in injury to rider or other persons.

CAUTION

This message, if disregarded, may result in damage to the motorcycle.

NOTE

Indicates important and useful messages for better understanding.

PERSONAL AND MOTORCYCLE INFORMATION

Name										
Door No. / Street										
Locality / Town										
City								Country		
Contact No.	Res:							Off:		
	Mobile:							Email:		
Licence No.								Valid till:		
Model								Color:		
Engine No.										
VIN. No.										
Tyre Make	Front:							Rear:		
Tyre Nos.	Front:							Rear:		
Battery make								Battery No.		
Sold by										
Date of Sale										

SAFE RIDING TIPS / GUIDELINES

- Before operating your new motorcycle, we request you to carefully read and follow the operating and maintenance instructions detailed in this manual for the safety of your own, your motorcycle and also that of others.
- Know and adhere to the rules of the road with respect to your driving country.
- Before starting the motorcycle, check for proper operation of brakes, clutch, gear shifter, handle bar controls, tyre pressures, fuel and oil levels, etc.
- Use only genuine Royal Enfield spare parts and approved accessories. Use of other manufacturer's parts may affect the performance of your motorcycle and render the motorcycle void of warranty. Visit your Royal Enfield Authorised Service Centre for details.
- Whenever refueling your motorcycle, please exercise utmost caution and carefully observe the following guidelines.
 - ★ Switch "OFF" mobile phones and other hand held electronic devices.
 - ★ Do not smoke and please ensure that there are no open flames or sparks near the motorcycle, when refueling or servicing the fuel system.
 - ★ Refuel in a well ventilated area with the engine turned off condition.
 - ★ Open the fuel tank cap slowly.
 - ★ Do not fill the fuel in tank to its brim. Please fill fuel till the bottom of anti splash plate, so as to leave sufficient air space in the fuel tank to allow for fuel expansion.

SAFE RIDING TIPS / GUIDELINES



WARNING

Royal Enfield cautions you against the use of certain non-standard parts such as aftermarket and custom made extended front forks or suspensions, which may adversely affect performance and handling. Removing or altering original parts may adversely affect performance and could result in accident.

- A new motorcycle must be operated according to the special running-in-procedure. See running-in-procedure mentioned in respective section.
- Operate motorcycle only at moderate speeds and out of traffic until you have become thoroughly familiar with its operation and handling characteristics under all conditions.

- Do not exceed the legal speed limit or ride too fast for existing conditions. Always reduce speed when poor riding conditions exist. High speed increases the influence of any other condition affecting stability and increases the possibility of loss of control.

NOTE

If you are an inexperienced rider we recommend that you obtain formal training on correct motorcycle riding techniques and become thoroughly familiar with the operation of your motorcycle. New riders should gain experience under various conditions while driving at moderate speeds. Pay strict attention to road surfaces and wind conditions. Any motorcycle may be subject to the following up-setting forces:

- ★ Wind blasts from passing vehicles.
- ★ Rough or uneven road surfaces.

SAFE RIDING TIPS / GUIDELINES

★ Slippery road surfaces.

These forces may affect the handling characteristics of your motorcycle. If this happens, reduce speed of the motorcycle to a controlled condition. Do not apply brake abruptly.

- Operate your motorcycle defensively. Remember that a motorcycle does not afford the same protection as an automobile in an accident. One of the most common accident situations occurs when the rider / driver of the other motorcycle / vehicle fails to see or recognise a motorcycle and turns into the oncoming motorcyclist.
- Wear an approved helmet, clothing and footwear suited for riding a motorcycle. Bright / light colours are best for greater visibility in traffic, especially at night. Avoid loose, flowing garments and scarves.
- When carrying a pillion rider, it is your responsibility instruct them on proper riding procedures.

- Do not allow other individuals, under any circumstances, to operate your motorcycle unless you know they are experienced, licensed riders and are thoroughly familiar with the operating conditions of your motorcycle.



WARNING

- Regularly inspect shock absorbers and front forks and look for leaks. Replace worn out parts. Worn out parts can adversely affect stability and handling.
- Exhaust gas contains poisonous carbon monoxide and chemicals, known to cause cancer, birth defects or other reproductive defects, durability / longevity operation of your motorcycle.
- For your personal welfare, all the listed service and maintenance recommendations should be performed. Lack of regular maintenance at the suggested intervals may affect the safe/durability/longevity operation of your motorcycle.

SAFE RIDING TIPS / GUIDELINES

- Avoid any contact with the exhaust system when hot. Wear clothing that will completely cover the legs while riding. The exhaust system gets very hot when the engine is running and remains too hot to touch, even after the engine is turned OFF. Failure to wear proper or protective clothing could result in serious injury.
- Motorcycle batteries contain lead, acids and chemicals known to cause cancer, birth defects or other reproductive harm. Exercise extreme caution while handling a battery, wash hands thoroughly whenever a battery is handled.
- Consult your Royal Enfield Authorised Service Centre regarding any questions or problems that occur in the operation of your motorcycle. Failure to do so may aggravate an initial problem, cause costly repairs and jeopardize your personal safety.
- Do not tow a motorcycle. The steering and handling of the towed motorcycle will be impaired due to the force of the towline. If a motorcycle must be transported, use a truck or a trailer.
- Do not pull a trailer behind a motorcycle. Towing a trailer may cause reduced braking efficiency, tyre overloading and unstable handling, as it may cause loss of control of the motorcycle in the front, leading to an accident.

RULES OF THE ROAD

- Be sure your number plate is installed in the position specified by law and it is clearly visible at all times.
- Ride at a safe speed that is consistent with the type of road surface you are on. Pay strict attention while riding on the following surfaces:
 - ★ Dusty
 - ★ Oily
 - ★ Icy
 - ★ Wet
 - ★ Sand
- Watch for loose debris, such as leaves, slippery substances or gravel that can hamper the stability of your motorcycle.
- Always ride on the correct side from the road center line, when meeting oncoming vehicles.
- Actuate your turn signals and exercise caution when passing other vehicles going in the same direction. Never try to pass another vehicle going in the same direction at street intersections, on curves, or when going up / or down a hill.
- At street intersection give the right-of-way to the motorcycle on your left or right. Do not presume you have the right-of-way.
- Adhere to the rules of the road with respect to your country when preparing to stop, turn or pass. While turning either right or left, watch for pedestrians, animals, as well as other vehicles.
- All traffic signs, including manual controls at intersections, should be obeyed promptly. Slow down at traffic signs near schools and caution signs at rail road crossings.
- When intending to turn, signal at least 100 feet (30.5 m) before reaching the turning. Be close to the center line (unless local rules require otherwise), slow down and then turn carefully.
- Never jump a traffic light. When a change is imminent from go to stop (or vice versa) at intersections, slow down and wait for the light to change to green. Never run through a yellow or red traffic light.

RULES OF THE ROAD

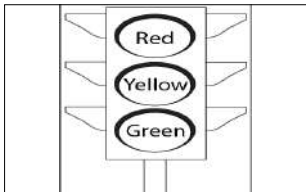

- Do not leave the curb or parking area without signaling. Be sure your way is clear to enter moving traffic. A moving line of traffic always has the right-of-way.
- When parking the motorcycle, park on a firm and flat surface to prevent it from falling over.
- Protect your motorcycle against theft. After parking your motorcycle, ensure that the steering head is locked and then remove the ignition key.

SIDE VIEW MIRRORS

Your motorcycle is equipped with convex mirrors and have a curved surface.

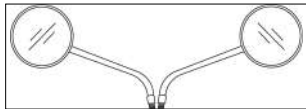

This type of mirror is designed to give a much wider view of the rear than a normal flat mirror. However, vehicles and other objects seen in this type of mirror will look smaller and farther away than when seen in a flat mirror.

Use care when judging the size or distance of vehicles / objects seen in these mirrors. Use the tool available in tool kit to loosen and adjust the side mirrors.

NOTE

To establish the relative distance of vehicles / objects behind your motorcycle through the mirrors, adjust each mirror in such a way, that a small portion of your shoulder is visible and a large portion behind your motorcycle is seen clearly with reference to your riding posture.

ACCESSORIES AND LUGGAGE

Royal Enfield offers a range of Genuine Motorcycle Accessories that have been fully approved and extensively tested alongside the motorcycle.

Therefore, the rider must be responsible for safe operation of the motorcycle when installing accessories or carrying additional weight.

Please adhere to the following guidelines when carrying a pillion, luggage or when fitting any accessories.

- Do not exceed 110 km/h when riding solo, carrying a pillion or payload on an accessory equipped motorcycle.
- Keep luggage weight concentrated close to the motorcycle and as low as possible; this minimizes sudden shift in the motorcycle's center of gravity.
- Distribute weight evenly on both sides of the motorcycle.

- Do not load bulky items behind the rider or add weight to the handlebars or front forks.
- Re-check the luggage periodically to ensure it is secured and will not shift while riding. Accessories mounted loosely may affect the riding of the motorcycle and affect the handling and stability of the motorcycle.
- Large surfaces such as fairings, windshields, backrests and luggage racks can adversely affect handling of the motorcycle. Use only Royal Enfield genuine motorcycle accessories which are model specific and follow installation procedure.

ACCESSORIES AND LUGGAGE



WARNING

- Do not load weight or install accessories incorrectly on the motorcycle. Doing so may affect the motorcycle's stability, handling characteristics and safe operation and could result in an accident causing serious injury or loss of life.
- Royal Enfield offers a range of Genuine Motorcycle Accessories that have been fully approved and extensively tested alongside the motorcycle.
- Royal Enfield cautions you against use of nonstandard parts such as aftermarket and custom made extended front forks which may adversely affect the performance and handling of the motorcycle. Removing or altering original parts may adversely affect the perfor-

mance of the motorcycle, causing an accident, which could result in serious injury or loss of life.

- Do not ignore model / design specifications. Doing so constitutes both motorcycle and accessories misuse which may adversely affect the handling and performance of the motorcycle causing an accident, which could result in serious injury or loss of life.

LUGGAGE CATEGORIES

- Do not exceed the maximum payload as defined in the GMA fitting instructions for panniers and top boxes.

TECHNICAL SPECIFICATIONS

ENGINE

Engine type	Liquid cooled, single cylinder, DOHC, 4 Valves
Bore	84 mm
Stroke	81.5 mm
Swept volume	452 cc
Compression ratio	11.5:1
Max power	29.44 kW (40.02 PS) @ 8000 rpm
Max torque	40 Nm @ 5500 rpm
Idle RPM	1300 rpm
Starting	Electric start
Air filter element	Paper element

Lubrication	Semi-dry sump
Cooling	Water cooled

IGNITION SYSTEM

Ignition	ECU controlled
Spark plug	0.8 mm to 0.9 mm
Spark plug gap	Champion

TECHNICAL SPECIFICATIONS

TRANSMISSION

Clutch	Wet multiplate, slip & assist
Primary drive	Gear
Primary ratio.....	2.028:1
Gear box	6 Speed
Gear ratio.....	1 st 3.083:1
	2 nd 2.059:1
	3 rd 1.600:1
	4 th 1.286:1
	5 th 1.087:1
	6 th 0.958:1
Secondary drive.....	Sprockets and chain (5/8 pitch)

Secondary ratio 3.000:1

CHASSIS

Frame..... Steel, tubular frame using engine as stressed member

Suspension

Front..... Telescopic forks, 41 mm, front wheel travel 140 mm

Rear Linkage type mono-shock, rear wheel travel 150 mm

Brakes

Front disc..... Hydraulic disc brake, 310 mm ventilated disc, double piston caliper

Rear disc Hydraulic disc brake, 270 mm ventilated disc, single piston caliper

Brake system..... Dual channel ABS

TECHNICAL SPECIFICATIONS

Type of wheel	Tyre size
Front (Alloy wheel)	120/70R17 58H (Tubeless tyre)
Rear (Alloy wheel)	160/60R17 69H (Tubeless tyre)

Type of wheel	Solo	With pillion
Front	32 psi	32 psi
Rear	36 psi	36 psi

Steering lock.....	Inbuilt
Fuel type.....	Unleaded gasoline
Ethanol content.....	Up to E20
Induction	Electronic fuel Injection, 42 mm throttle body, Ride by Wire System
Fuel tank capacity.....	11* L
Low fuel warning.....	2.5 L ± 0.5* L
Dead stock.....	0.15* L

* The above values are approximate and the actual fuel filling capacity will vary from the values mentioned.

TECHNICAL SPECIFICATIONS

ELECTRICALS

Alternator output	280 W @ 1200 rpm
Generation.....	Alternator, III Phase
System.....	12 V - DC
Battery.....	12 V - 8 Ah VRLA
Head lamp	12 V, FPL 1.5 W LED, low beam 12.12 W, high beam + low beam 14.22 W
Brake lamp	12 V, 1.4 W
Tail lamp	12 V, 0.31 W
License plate illuminator	12 V - LED
Instrument cluster	Colour TFT (Thin Film Transistor)

Turn signal	Front - 12 V, 2 W x 1 no Rear - 12 V, 4.2 W x 1 no
Hazard warning	Front - 12 V, 2 W x 2 nos Rear - 12 V, 4.2 W x 2 nos
Horn.....	12 V, 2.5 A
Starter motor.....	12 V - 0.7 kW
Charger port.	USB 2.0 Type C - 5 V, 2 A output



WARNING

Using bulbs/electrical gadgets other than specified rating will lead to overloading/erratic behavior/premature failure of electrical system. Modifications or fitments which are not approved by Royal Enfield, will seriously affect the performance of the vehicle and will render the warranty void.

TECHNICAL SPECIFICATIONS

DIMENSIONS

Length	2090 mm
Width.....	833 mm
Seat height	780 mm
Height.....	1125 mm (Without mirrors)
Wheelbase.....	1440 mm
Ground clearance	169 mm

WEIGHTS

Kerb weight (90% fuel and oil)	185 kg
Gross vehicle weight	376 kg

NOTE

- Values / Dimensions given above are for your guidance only.
- In view of continuous improvements being done on our products, the specifications are likely to change without prior notice.
- Do not use the vehicle beyond the allowed gross weight. The suspensions and tyres are designed to perform only to the maximum gross vehicle weight.

RECOMMENDED LUBRICANTS

ENGINE OIL		COOLANT	FRONT FORK OIL	BRAKE FLUID
Grade	10W40 API SN, JASO MA2, Semi Synthetic	TOTAL COOLELF AUTO SUPRA -37 °C	SS-8	DOT 4*
Capacity	1st dry fill: 2.4 L	Radiator: Dry fill - 970 ml Service fill - 840 ml	540 cm ³ (Each fork leg)	Front: 88.3 ml
	Refill: 2.1 L for oil service (Including filter change)	Expansion Tank: Fill to max mark - 200 ml		Rear: 75.2 ml

* Do not mix DOT 4 or other brake fluid together.

NOTE

1. Coolant is ready to use and does not require mixing.
2. Recommendation subject to change without notice.
3. The above values are approximate and the actual capacity will vary.
4. Use of wrong oil grade will reduce the life of the moving parts and seriously affect performance.

MOTORCYCLE IDENTIFICATION NUMBERS

FRAME NUMBER

The VIN is a 17 digit number punched on the right side steering head tube in the form of punching.

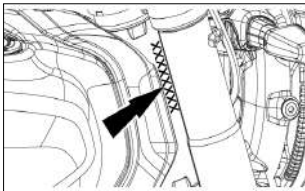

ENGINE NUMBER

The engine number is a 14 digit number punched on the bottom of gear pedal connector rod.

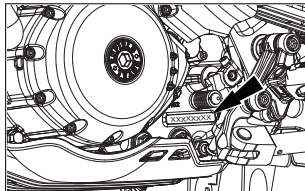

CAUTION

It is illegal to tamper with or alter the VIN/Engine numbers of the motorcycle as it will not only be against the law but will render the vehicle registration and warranty void.

LOCATION OF KEY PARTS

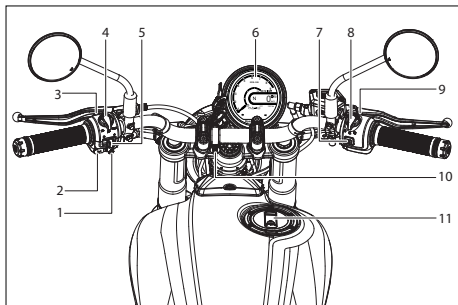

1. Joystick
2. Horn switch
3. Home button
4. High/Low beam/Flashing switch
5. Turn signal switch
6. Instrument cluster
7. Mode switch
8. Ignition/Engine kill switch
9. Hazard switch
10. USB charger port
11. Fuel tank cap

LOCATION OF KEY PARTS

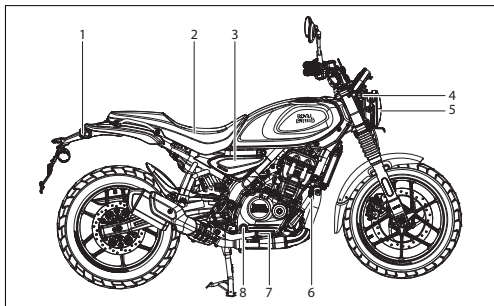

1. Right trafficator rear
2. Seat
3. Right side panel
4. Right trafficator front
5. Head lamp
6. Horn
7. Rear brake pedal
8. Oil level window

LOCATION OF KEY PARTS

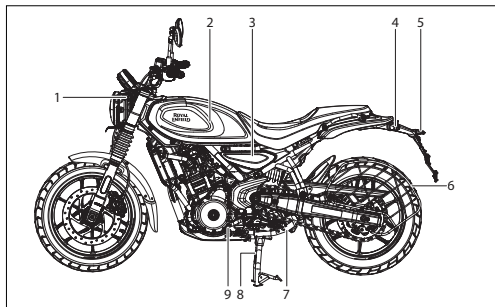

1. Left trafficator front
2. Fuel tank
3. Left side panel
4. Left trafficator rear
5. License plate illuminator
6. Saree guard (If fitted)
7. Side stand
8. Center stand
9. Gear change lever

Disclaimer

The LH, RH and Top view parts displayed above are for reference purposes only. These parts can differ based on the selection of motorcycle variants.

OPERATION OF CONTROLS

IGNITION KEY



"OFF"



"ON"

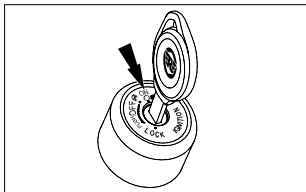

NOTE

- Key can be removed only if ignition is in OFF or steering is locked.

- Key is common for ignition, fuel tank lock, steering lock and seat.
- Key can be removed from fuel tank and seat only in locked position from the key slots.



WARNING

- Do not switch OFF ignition while riding the motorcycle.
- Doing so can cause a potential accident, resulting in serious injury to both rider and other road users, besides causing severe damage to the motorcycle.

STEERING LOCK

- Turn the handle bar to extreme left position.
- Push the key inside at OFF position, press and further turn to anticlockwise direction to lock the steering system then turn the key in the clockwise direction to unlock the steering.

OPERATION OF CONTROLS

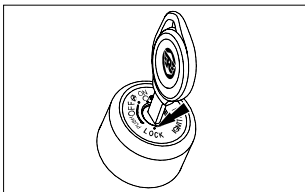

FUEL TANK CAP

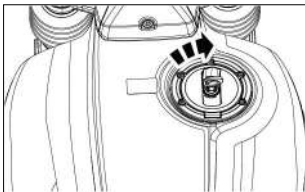

- Lift key flap on fuel tank cap and insert key.

- Turn key clockwise to open.
- Press cap to lock with key in position.
- Remove key from cap and close flap.



WARNING

- This bike have got the fuel cap on the RHS of the tank and therefore while filling the fuel, make sure the fuel level doesn't go above the splash arrestor in the tank.
- Over filling may result in gasoline entering the EVAP canister and may damage the evaporative emission system.

CAUTION

- Gasoline vapour is highly explosive. Please ensure there are no open flames or sparks nearby while refueling and fill fuel only in a well ventilated area.
- Please ensure gasoline does not spill on painted surfaces. In case fuel spills over the painted surfaces wipe it off immediately as it may leave a permanent stain.
- Do not smoke while refueling or when fuel tank cap is open.

OPERATION OF CONTROLS

FUEL FILLING LEVEL

1. Fuel filler collar
2. Anti splash plate
3. Maximum fuel level

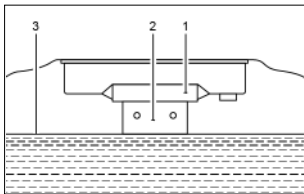

IGNITION/ENGINE KILL SWITCH



"OFF"



"ON"

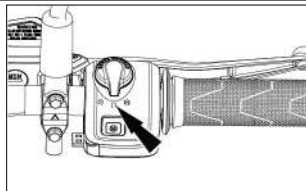

CAUTION

- Turn OFF ignition switch when engine is not running. Failure to do so will discharge the battery due to the headlamp being continuously ON.

E-START SWITCH



Push and hold electric start switch until engine starts for a maximum of 5 seconds.

OPERATION OF CONTROLS

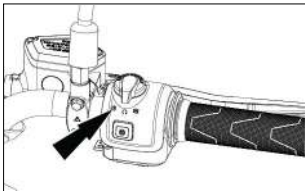

CAUTION

- In case of prolonged stoppage of vehicle, please turn off ignition key to avoid discharge of battery.

HAZARD LIGHT SWITCH

- Press the hazard button to hazard blinking ON.

CAUTION

- Hazard flashing will create a strain on battery. Do not use hazard warning for longer period unless necessary.

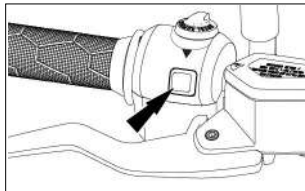

Methods to activate hazard flasher:

- Ignition switch ON, press the hazard switch. Hazard will work unless manual deactivation (OFF).
- Ignition switch ON, press the hazard switch hazard will start working - Ignition switch OFF
 - Hazard will keep working for a duration of 30 minutes
 - Unless manual deactivation (OFF).
- Hazard flasher cannot be activated in ignition switch OFF condition.

OPERATION OF CONTROLS



WARNING

- Turn signals do not work when the hazard light switch is "ON".
- All the trafficator lamps will flash simultaneously.

HORN



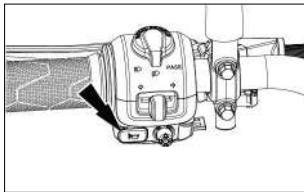

Press the horn button to sound horn.

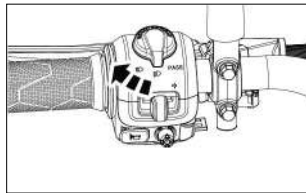

HIGH BEAM/LOW BEAM SWITCH

- When the headlamp is in "ON" condition High / Low beam will be selected by toggling the switch. High beam indicator tell tale located in instrument cluster will glow when high beam is selected.



-  High beam
-  Low beam

OPERATION OF CONTROLS

FLASH SWITCH

Push the switch for headlight flash.

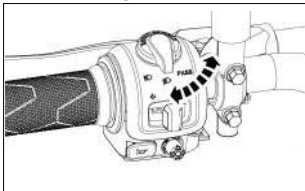

TURN SIGNAL SWITCH

- ⇐ Left turn signal "ON"
- ↑ "OFF" (Push to cancel)
- ⇒ Right turn signal "ON"

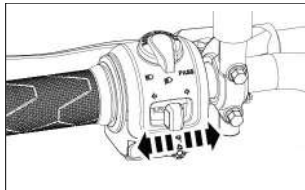

Push the button from OFF position to either left or right before turning as needed. To cancel the turn signal lights, push the switch in after it has returned to the center position.

OPERATION OF CONTROLS

HOME BUTTON

Home button on left side switch cube, it's used to go back option.

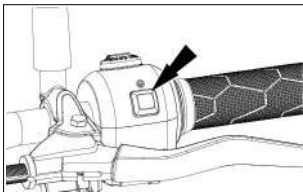

MODE BUTTON

Mode button on right side switch cube, it's used to change the riding modes.

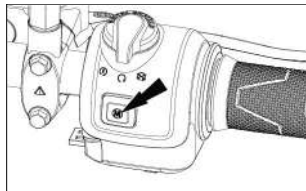

RIDING MODE

- The ride mode can be viewed and changed by pressing the mode button on the RH switch cube.
- The ride mode appears on the home screen and following modes are available.
 - ★ Performance + ABS ON
 - ★ ECO + ABS ON

OPERATION OF CONTROLS

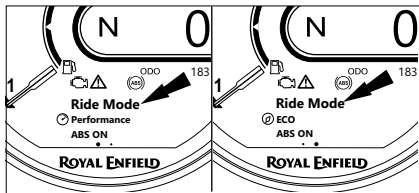

NOTE

- To change the mode from performance + ABS ON to ECO + ABS ON in static condition, press the MODE button two times, the display shows ECO + ABS ON and leave the screen for a few seconds the ride mode changes.
- Likewise we can change the modes to ECO + ABS ON and Performance + ABS ON.

- In dynamic condition also we can change the ride mode from performance to ECO and ECO to performance, with some below conditions to be met.
 - ★ Throttle to be closed
 - ★ Clutch should be pressed or vehicle to be in Neutral gear
- If the above said condition are not met cluster will not allow to change the mode and it will deny the mode with below note in cluster home screen.

OPERATION OF CONTROLS

SIDE PANEL LEFT

- To access the left side panel loosen and remove the hexagon bolt with washer (1 No) by using 10 mm spanner available in the tool kit. Press the right side back button lock and slide backward direction to remove the panel.

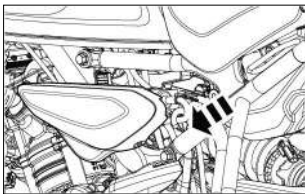

SIDE PANEL RIGHT

- To access the right side panel loosen and remove the hexagon bolt with washer (1 No) by using 10 mm spanner available in the tool kit. Press the left side back button lock and slide backward direction to remove the panel.

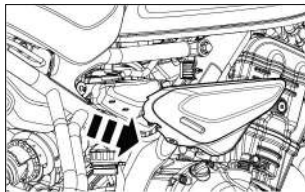

SEAT DISMANTLING

- Insert the key on the seat key slot and turn clockwise direction.

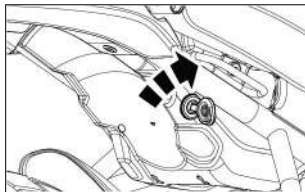

OPERATION OF CONTROLS

- Slide the seat towards backward direction to remove the seat.

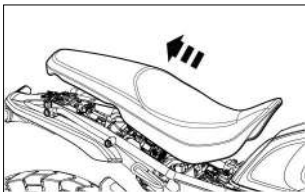

NOTE

- Place the removed seat in a safe location to prevent from scratches and dirt.

SEAT ASSEMBLY

- Place the seat and slide the seat towards backward direction.

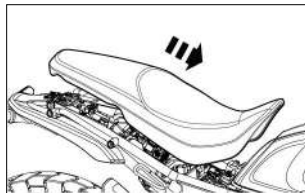

OPERATION OF CONTROLS

- Ensure the seat aligned with frame and press seat to lock with key in position.

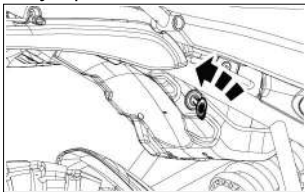

JOYSTICK

- Joystick is used for navigating up, down, left and right direction and to select also.

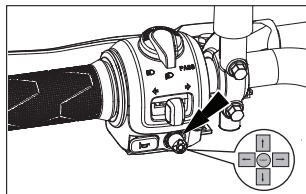

IF PRESS JOYSTICK LEFT

- The following details are displayed on the advanced dashboard.
 - ★ Trip 1
 - ★ Trip 2
 - ★ Fuel range
 - ★ Instantaneous fuel consumption

OPERATION OF CONTROLS

- ★ Battery gauge
 - ★ Service Due In
 - ★ Engine temperature
- The above details can be customized in my vehicle option available in the settings menu.

For Analog Screen

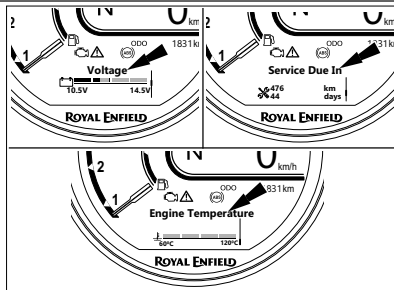
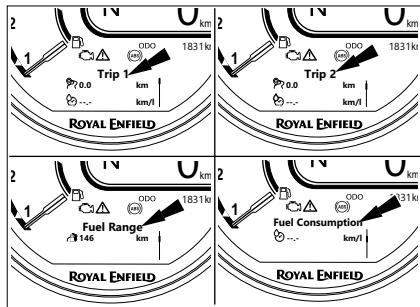

- Press the joystick right from the first detail to go back to the home screen.
- The home screen can be switched only from the first option in the advanced dashboard.

NOTE

- We have four segments in battery gauge as shown and each segment carries 1V.

OPERATION OF CONTROLS

- Example: If 2 segments are filled completely battery voltage is 12.5 V, if upto 3 segments half filled it denotes as 13 V.
- Likewise we have four segments in temperature gauge as shown and each segments carries 15°C.
- Example: If 2 segments are filled completely gauge denotes as 90°C, if upto 3 segments half filled it denotes as 98°C (approximately).

For Digital Screen

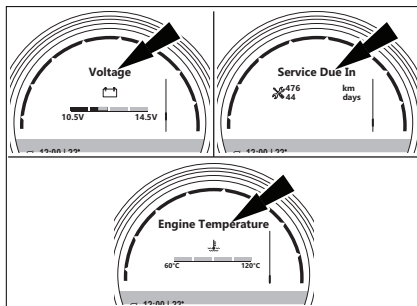
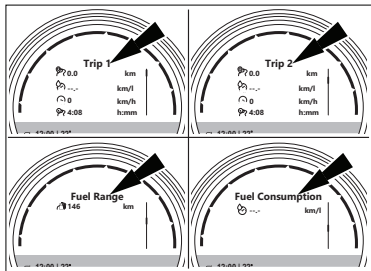

Distance to empty

- Distance to empty is a feature which shows how much distance the vehicle can run while in reserve tank/low fuel indicator starts glowing.
- This will start showing in the cluster when fuel gauge shows low fuel indicator.

OPERATION OF CONTROLS

IF PRESS JOYSTICK UP

- The following settings options are available.
 1. Appearance
 2. Trip preference
 3. My vehicle
 4. System
 5. Information
 6. Favorite Apps
- Press the home button on the LH switch cube to go back.

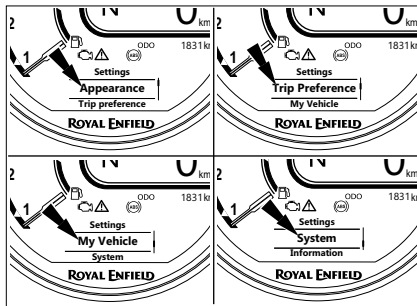
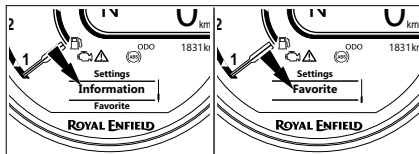

1. APPEARANCE

- From the center of settings menu press the joystick with the appearance selected to explore the options.
- The following options will appear on the screen.

OPERATION OF CONTROLS

- i. Golden line
- ii. Background
- iii. Brightness
- iv. Screen type

- The options shall be navigated by joystick up & down press and selected by joystick center press.

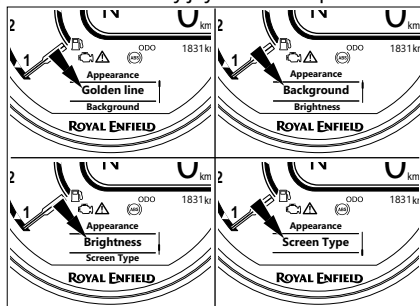

- Press the home button on the LH switch cube to go back.

i. Golden line

- Center press the joystick with the golden line option selected will open the details to show adjacent to the golden line on the TFT screen.
- The following options will be shown on the display.
 - ★ ODO
 - ★ Trip 1
 - ★ Trip 2
 - ★ Outside temperature
- The options shall be navigated by the use of joystick up & down press and selected by the use of joystick center press.
- Press the home button on the LH switch cube to go back.

OPERATION OF CONTROLS

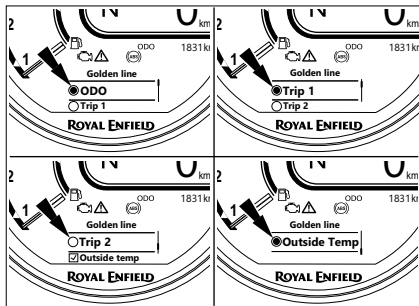

ii. Background

- Center press the joystick with the background option selected to change the background theme of the instrument cluster.
- There are two options available: Auto and dark theme.

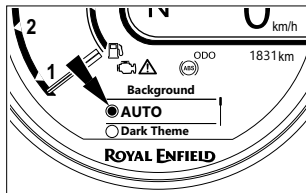

- The options shall be navigated by joystick up & down press and selected by joystick center press.
- Press the home button on the LH switch cube to go back.

NOTE

Default it will be in auto theme (day time - light theme & night time - dark theme).
The dark theme shall be applicable to both Analog and Digital screen type.

OPERATION OF CONTROLS

iii. Brightness

- Center press the joystick with the brightness option selected to change the brightness of the instrument cluster.
- The brightness shall be increased by joystick right press and decreased by joystick left press.
- Press the home button on the LH switch cube to go back.

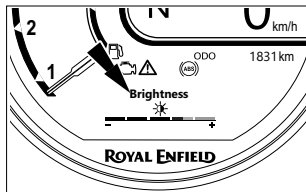

NOTE

Brightness can be adjusted only in the dark theme.

iv. Screen type

- Center press the joystick with the screen type option selected to change the screen type of the instrument cluster.
- There are two options available: Analog and digital screen.
- Default screen will be in analog type.
- The options can be navigated by joystick up and down press and selected by joystick center press.
- Press the home button on the LH switch cube to go back.
- Screen can be changed from analog to digital by long pressing the Mode button on the RH switch cube.

OPERATION OF CONTROLS

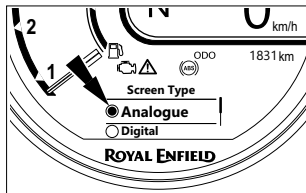

2. TRIP PREFERENCE

- From the settings menu center press the joystick with the trip preference selected to explore the options.
- The following options are available in trip preference menu.
 - i. Reset trip
 - ii. Analogue content
 - iii. Digital content

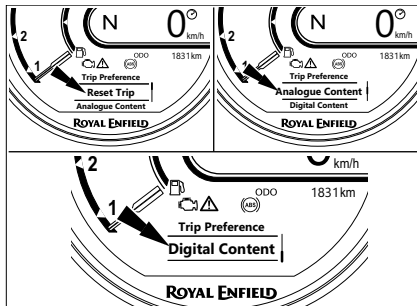

- The options shall be navigated by joystick up and down press and selected by joystick center press.
- Press the home button on the LH switch cube to go back.

OPERATION OF CONTROLS

i. Reset trip

- Center press the joystick with the reset trip option selected to reset the trip.
- There are two options available: Reset trip 1 and reset trip 2.

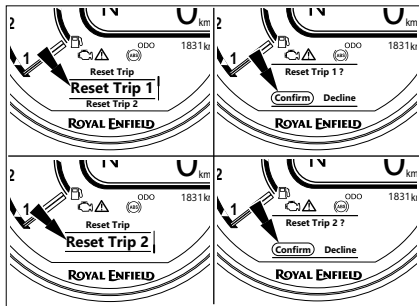

- The options can be navigated by joystick up and down press and selected by joystick center press.
- Selecting either reset trip 1 or reset trip 2 will show a confirmation popup for reset.
- Press the home button on the LH switch cube to go back.

ii. Analogue content

- Center press the joystick with the analogue content option selected to explore the options.
- The following options are available.
 - ★ Trip distance
 - ★ Average fuel consumption
 - ★ Trip time
 - ★ Average speed
 - ★ Max speed

OPERATION OF CONTROLS

- The options can be navigated by joystick up and down press and selected by joystick center press.
- Any two of the above options will be shown in the analog screen.

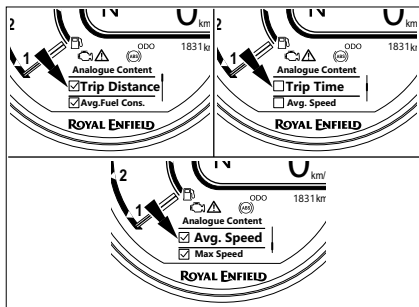

- Press the home button on the LH switch cube to go back.

iii. Digital content

- Center press the joystick with the digital content option selected to explore the options.
- The following options are available.
 - ★ Trip distance
 - ★ Average fuel consumption
 - ★ Trip time
 - ★ Average speed
 - ★ Max speed
- The options can be navigated by joystick up and down press and selected by joystick center press.
- Any four of the above options will be shown in the digital screen.
- Press the home button on the LH switch cube to go back.

OPERATION OF CONTROLS

3. MY VEHICLE

- From the settings menu center press the joystick with the my vehicle option selected to explore the options.
- The following options are available in my vehicle menu.
 - ★ Trip 1
 - ★ Trip 2
 - ★ Fuel range
 - ★ Instantaneous fuel consumption
 - ★ Battery gauge
 - ★ Service Due In
 - ★ Engine temperature
- The content to be shown in the advanced dashboard can be customized based on rider preference in my vehicle menu.

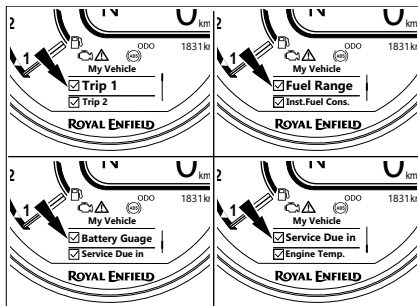

- The options can be navigated by joystick up and down press and selected by joystick center press.
- Press the home button on the LH switch cube to go back.

OPERATION OF CONTROLS

4. SYSTEM

- From the settings menu center press the joystick with the my vehicle option selected to explore the options.
- The following options are available in the system menu.
 - i. Clock
 - ii. Speed/Distance
 - iii. Fuel consumption
 - iv. Temperature
 - v. Language
 - vi. Factory reset
- The options can be navigated by joystick up and down press and selected by joystick center press.
- Press the home button on the LH switch cube to go back.

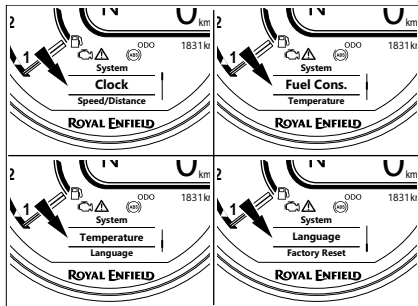

i. Clock

- Center press the joystick with the clock option selected to explore the options.
- The following options are available in the clock menu.
 - ★ 24H

OPERATION OF CONTROLS

- ★ 12H
- ★ Set time

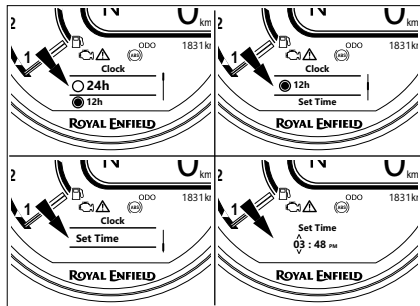

- The options can be navigated by joystick up and down press and selected by joystick center press.

- Press the home button on the LH switch cube to go back.

NOTE

If the mobile phone is connected to the vehicle only the hour format (i.e. 24H & 12H) can be selected based on the rider preference.

If the mobile phone is not connected to the vehicle all the options (i.e. 24H, 12H & Set Time) can be selected.

- In the set time option, time can be adjusted by joystick up, down, left & right press.
- Joystick up & down press is used to increase or decrease the hour, minute & time format values, while joystick left & right is used to switch between hour, minute & time format selection.

OPERATION OF CONTROLS

ii. Speed/Distance:

- Center press the joystick with the speed/distance option selected to explore the options.
- The following options are available in the menu.
 - ★ Kilometers
 - ★ Miles
- The options can be navigated by joystick up and down press and selected by joystick center press.
- Press the home button on the LH switch cube to go back.

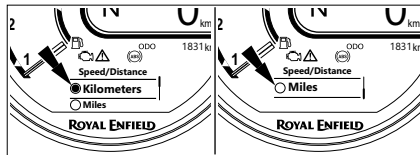

iii. Fuel consumption

- Center press the joystick with the fuel consumption option selected to explore the options.
- The following options are available in the menu.
 - ★ km/l
 - ★ L/100 km
 - ★ mpg (UK)
 - ★ mpg (US)
- The options can be navigated by joystick up and down press and selected by joystick center press.
- Press the home button on the LH switch cube to go back.

NOTE

If the speed/distance is in km then either km/l or L/100 km options are available to select and the remaining options will be grayed out.

OPERATION OF CONTROLS

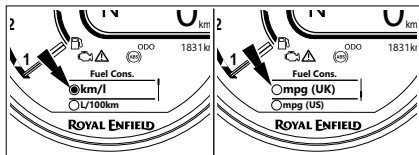

If the speed/distance is not in km (in mpg) then either mpg (UK) or mpg (US) options are available to select and the remaining options will be grayed out.

iv. Temperature

- Center press the joystick with the temperature option selected to explore the options.
- The following options are available in the menu.
 - ★ Celsius
 - ★ Fahrenheit
- The options can be navigated by joystick up and down press and selected by joystick center press.

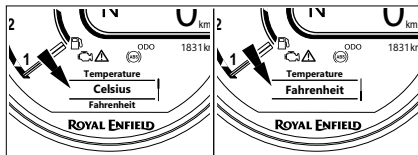

- Press the home button on the LH switch cube to go back.

v. Language

- Center press the joystick with the language option selected to explore the options.
- The following options are available in the menu.
 - ★ English
 - ★ Italian
 - ★ Spanish
 - ★ Portuguese

OPERATION OF CONTROLS

- ★ German
- ★ French
- The options can be navigated by joystick up and down press and selected by joystick center press.

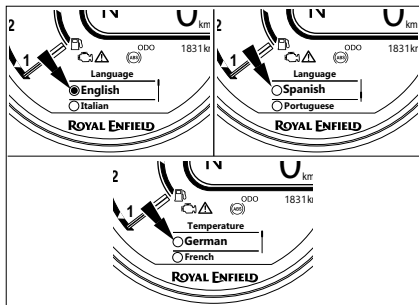

- Press the home button on the LH switch cube to go back.

vi. Factory reset

- Center press the joystick with the factory reset option selected to reset all settings.
- A confirmation popup will appear on the display.

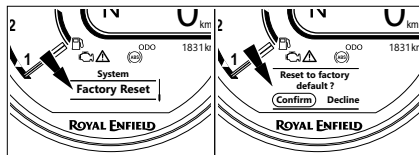

- Press the home button on the LH switch cube to go back.

5. INFORMATION

- From the settings menu center press the joystick with the information option selected to explore the options.

OPERATION OF CONTROLS

- The following options are available in the system menu.
 - i. Notification
 - ii. Firmware version
- The options can be navigated by joystick up and down press and selected by joystick center press.

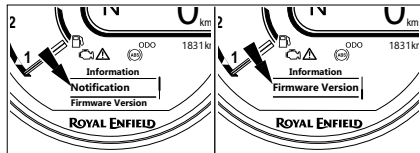

- Press the home button on the LH switch cube to go back.

i. Notification

- Center press the joystick with the notification option selected to explore the options.
- The following options are available in the menu.
 - ★ Messages
 - ★ Incoming call
 - ★ Weather alerts
 - ★ Contextual alert
 - ★ Vehicle check alert
- The options can be navigated by joystick up and down press and selected by joystick center press.
- Press the home button on the LH switch cube to go back.

OPERATION OF CONTROLS

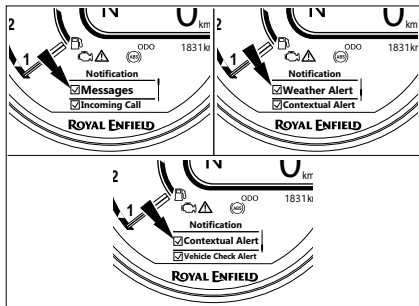

ii. Firmware version

- Center press the joystick with the firmware version option selected to view the current firmware version of the instrument cluster.
- Press the home button on the LH switch cube to go back.

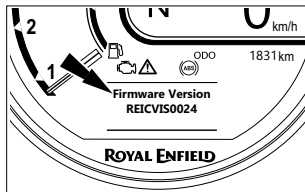

6. FAVORITES

- From the settings menu center press the joystick with the favorite apps option selected to explore the options.
- The following options are available in the system menu.
 - Navigation
 - Music
 - Android call or phone

OPERATION OF CONTROLS

iv. Android message

v. Compass

- The options can be navigated by joystick up and down press and selected by joystick center press.
- Press the home button on the LH switch cube to go back
- Scan the QR Code, to download, Install, register and to know more about the TFT cluster mobile connectivity information.

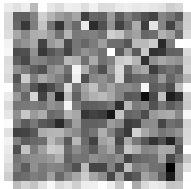

Smartphones compatible version to use RE Mobile app:

- Android: Our app's minimum supported version will be two versions behind the current Android OS.
- iOS: The minimum supported iOS version will be one version behind the current iOS release.

NOTE

- If mobile phone connectivity is disabled from the vehicle, the favorite function will also get disabled.
- Huawei phones are not compatible with our app; we do not offer support for them.

OPERATION OF CONTROLS

i. Navigation

- Center press the joystick with the navigation option selected to explore the options.
- The options can be navigated by joystick up and down press and selected by joystick center press.

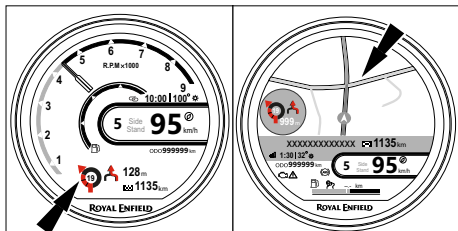

- Press the home button on the LH switch cube to go back.

ii. Music

- Center press the joystick with the music option selected to explore the options.
- The options can be navigated by joystick up and down press and selected by joystick center press.

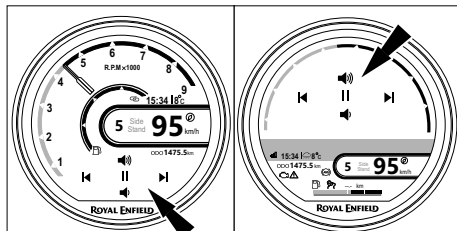

- Press the home button on the LH switch cube to go back.

NOTE

For iOS, Apple music alone will work.

OPERATION OF CONTROLS

iii. Android Call or Phone

- Center press the joystick with the phone option selected to explore the options.
- The options can be navigated by joystick up and down press and selected by joystick center press.

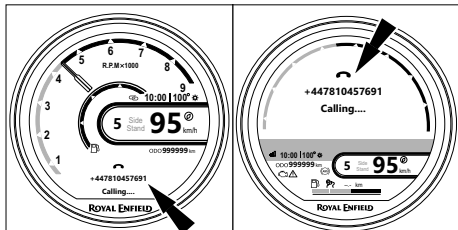

- Press the home button on the LH switch cube to go back.

iv. Android Message

- Center press the joystick with the message option selected to explore the options.
- The options can be navigated by joystick up and down press and selected by joystick center press.

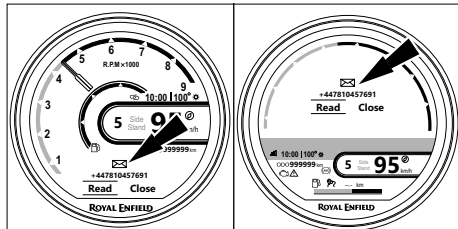

- Press the home button on the LH switch cube to go back.

NOTE

For iOS, call and message will not be supported.

OPERATION OF CONTROLS

v. Compass

- Center press the joystick with the compass option selected to explore the options.
- The options can be navigated by joystick up and down press and selected by joystick center press.

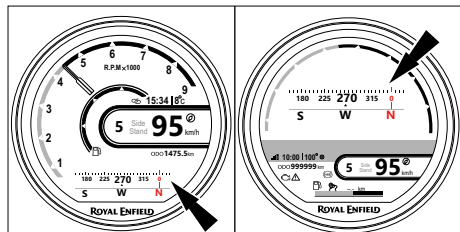

- Press the home button on the LH switch cube to go back.

NOTE

Compass will function, only when there is active navigation.

OPERATION OF CONTROLS

INSTRUMENT CLUSTER

For Analog Type

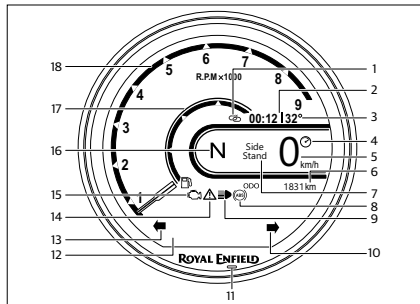

1. Mobile connectivity symbol
2. Real time clock (RTC)
3. Outside air temperature

4. Ride mode
5. Speed indicator (km/miles can be selected based on country)
6. Odometer (km/miles can be selected based on country)
7. Side stand indicator
8. ABS warning lamp
9. High beam indicator
10. Right turn indicator
11. Ambient sensor
12. Home screen
13. Left turn indicator
14. General warning symbol
15. Engine MIL
16. Gear indication
17. Fuel bar gauge
18. Engine RPM gauge

OPERATION OF CONTROLS

For Digital Type

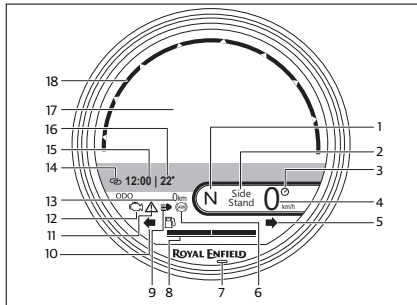

1. Gear indication
2. Side stand indicator
3. Ride mode

4. Speed indicator (km/miles can be selected based on country)
5. Right turn indicator
6. ABS warning lamp
7. Ambient sensor
8. Fuel bar gauge
9. High beam indicator
10. Right turn indicator
11. General warning symbol
12. Engine MIL
13. Odometer (km/miles can be selected based on country)
14. Mobile connectivity symbol
15. Real time clock (RTC)
16. Outside air temperature
17. Home screen
18. Engine RPM gauge

OPERATION OF CONTROLS

CLOCK

- Display in 24 hours format type.
- Will reset to 00:00 when battery is disconnected.

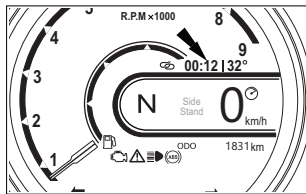

SERVICE REMINDER

- In case of service reminder symbol is ON. Please plan for scheduled service at an authorised service center.
- Service reminder can be reset only by authorised personnel at service centre after service is completed.

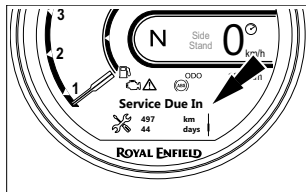

- Service reminder symbol will flash on as per below distance input from odometer.
 - 1st service - 450 km
 - 2nd service - 4,900 km
 - From there on for every 5,000 km from previous value (ex: 9,900 km, 14,900 km etc.)

OPERATION OF CONTROLS

ODOMETER

- Displays the cumulative kilometers the vehicle has covered.

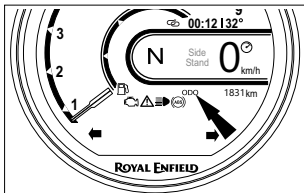

GEAR POSITION INDICATION

- Displays the gear position in which the vehicle is traveling.
- When in neutral the indication will be "N".
- When in gear the appropriate number between 1 to 6 will be displayed.

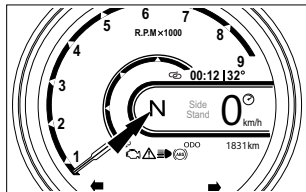

TELL TALES

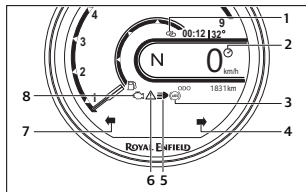

OPERATION OF CONTROLS

- **(1) Mobile connectivity symbol** - It shows mobile connecting and disconnecting indication.
- **(2) Ride mode** - It can view both performance mode and ECO mode indication based on the vehicle riding condition.
- **(3) ABS** - Will be continuously ON during initial check up (until or after vehicle running for a particular distance / speed) and will turn OFF if system is ok, then will light up again in case of any ABS system malfunction.
- **(4) Turn right** - Right turn signal ON.
- **(5) High beam indication** - Head lamp high beam ON.
- **(6) Warning symbol** - This indicator glows whenever the vehicle components fault.
- **(7) Turn left** - Left turn signal ON.
- **(8) Engine MIL** - Will be continuously ON in case of EMS malfunction.

NOTE

- Tell tales lights will switch "OFF" after engine is started.

CAUTION

- Do not run motorcycle in case the malfunction remains "ON" continuously as it can cause severe damage to the ECU & Sensors. Please visit the nearest authorised Royal Enfield dealer to diagnose & rectify the defect in the EMS.
- Do not run motorcycle in case the ABS indicator lamp continuously "ON".

OPERATION OF CONTROLS

ABS INDICATOR LAMP

- When the ignition and engine kill switch is switched in "ON" position the ABS sign will glow and remain "ON" till the motorcycle attains a speed of 5 km/h and turns "OFF". If light up again in case of any ABS system malfunction.

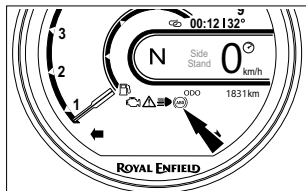

CAUTION

- Do not run motorcycle in case the ABS indicator lamp is "ON" continuously above 5 km/h.

FUEL GAUGE

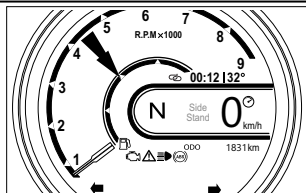

- Digital with 4 segment bar graph.
- Last segment blinking along with low fuel tell tale "ON" for low fuel condition.



WARNING

- Do not use the motorcycle for long duration with the fuel indication in last segment blinking. Refuel at the earliest.

OPERATION OF CONTROLS

- Failure to do so will cause the motorcycle to run out of fuel and get stranded in addition to causing serious damage to the fuel pump.

CHARGER PORT

- Charger port is located on the center part of handle bar.

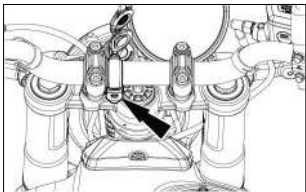

WARNING

- Recommended not to use in rainy conditions to avoid damages to smart phones and charger, RE shall not be liable for any damage to smart phones.
- Do not use any other device other than mobile phones, only one mobile shall be charged at one point of time.
- Ensure proper insertion of USB cable, damages due to hard / wrong insertion of cable will not be entertained in warranty.
- Do not leave the USB port cap opened / closed partially to avoid any short circuit when not in use.
- Do not insert any metal or conductive materials inside USB charging port which may lead to short circuit.

OPERATION OF CONTROLS

NOTE

- Charging port is provided only for charging purpose and no data transfer is enabled.
- Only constant charging mode is provided, fast / dash charging mode is not provided to be compatible with multiple mobile phones and cannot be compared with the performance of original smartphone chargers.
- Duration of charging can be higher and will vary for different mobile phones depending on smart phone battery capacity, SOC and smart phone charging circuits.

CAUTION

- Customer to ensure USB port cap is closed and locked properly when not in use, warranty will not be provided if port cap is damaged and not sealed properly.

- If high current draw greater than 2.5 A is observed USB charger will shutdown please check your smart phone battery current ratings before using.
- USB charger will function only when engine is in running condition.
- Use standard approved and high quality USB cables for proper functioning.

WARNING INDICATIONS AND SAFETY SYSTEMS

ANTI-LOCK BRAKING SYSTEM (ABS)

- Anti-lock braking system (ABS) will help prevent the brakes from locking the wheels, during sudden application of the brakes at high speeds or at low friction surfaces. This will help the rider to have better traction and control over the motorcycle and prevent the motorcycle from skidding which can cause an accident.

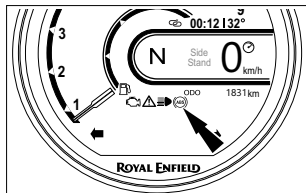

- In the event of a sudden and hard application of the brakes by the rider, the sensors in the braking system

will signal the ABS modulator to momentarily and continuously reduce the hydraulic pressure and thereby prevent the brakes from locking the wheels while reducing the speed of the vehicle. This will help the rider to control the motorcycle.

- An ABS indicator lamp is provided in the cluster (as shown in the adjacent image) to warn the rider in the event of any malfunction of the ABS.
- When the ignition and engine kill switch are switched in "ON" position the ABS sign will glow and remain "ON" till the motorcycle attains a speed of 5 kmph and turns "OFF". This indicates the ABS is functioning properly. If the ABS indicator lamp does not switch "OFF" and remains continuously "ON" at higher speeds, it is recommended not to drive the ABS motorcycle. Get the brake system inspected and corrected through a nearest Authorised Royal Enfield Service Centre. Failure to do so can result in a serious injuries and loss of life.

WARNING INDICATIONS AND SAFETY SYSTEMS

CAUTION

- ABS is a safety feature to help prevent locking of wheels during panic application of brakes. It is by no means a substitute for good riding practices and anticipatory braking.
- Please ride carefully and apply brakes cautiously, especially while cornering. ABS cannot estimate the "weight shifts" and momentum of the motorcycle while negotiating a corner and therefore prevent skidding due to loss of traction.
- Please anticipate the stopping distance required for the speed of travel and apply brakes well in advance so as to bring the motorcycle to a safe stop.
- Ensure instrument cluster is in proper functioning as it is an integral part of ABS system.

- Please apply both brakes simultaneously to stop with better traction and control of the motorcycle.
- Failure to adhere to the above can cause an accident resulting in serious injuries and loss of life.



WARNING

- Always use the approved front / rear tyres and rear sprocket by Royal Enfield to ensure correct ABS operation.
- Do not make any changes to the suspension travel.
- Only use recommended spare parts on the brake system which have been approved by Royal Enfield.
- ABS does not reduce braking distance. In certain circumstances, ABS may result in a longer stopping distance.

WARNING INDICATIONS AND SAFETY SYSTEMS

CAUTION

- Visually inspect for damaged teeth on the front and rear ABS toner rings.

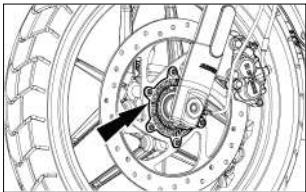

- Inspect for damages and dents on the face of the teeth.
- The teeth edges should be consistent in appearance. In case if a toner ring is found to be damaged or bent, it is recommended to visit nearest dealership for necessary action.

- Inspect for debris at the end of the wheel speed sensors - front & rear, if contamination is observed, it is recommended to clear it suitably or you may visit to nearest dealership for necessary action.

ROLL OVER SENSOR

In the event of motorcycle falling over in either of its sides with the engine running and the gears engaged the roll over sensor will disable fuel systems and switch OFF the engine. This is to prevent any damage to the motorcycle and its rider.

To reset the roll over sensor and reactivate the fuel systems.

- Ensure the motorcycle is made upright and is on its center stand.
- Ensure gears are in correct neutral and the neutral lamp is glowing in the instrument console.
- Switch OFF both ignition & stop switches, wait for a few seconds and switch ON the ignition and stop switch again, to start the engine.

WARNING INDICATIONS AND SAFETY SYSTEMS

DO'S AND DON'TS: (ABS)

DO'S	DONT'S
<ul style="list-style-type: none">■ While starting the engine do check the ABS indicator glows ON and turns OFF when the vehicle speed exceeds 5 km/h.■ Please check the brake fluid level in the front and rear brake reservoir and ensure there is no leak in the brake systems.■ Apply both the brakes simultaneously for better efficiency.■ In the event of the ABS indicator remaining continuously ON, please take the motorcycle to a nearest Authorised Royal Enfield Service Centre to inspect the brake system.	<ul style="list-style-type: none">■ Do not release the brake lever / pedal when pulsations are felt during hard application of the brakes in an emergency situation. The pulsations only indicate that the ABS is activated.■ Do not apply only the front or rear brake as it can lead to inefficient braking.

PRE-OPERATIONAL CHECKS

A careful check of the following must be carried out every time before riding and specially after long periods of storage to determine if any additional maintenance is necessary.

1. Adequate fuel in the tank for the journey planned.
2. Tyre for correct pressure, abrasions or cuts.
3. Ensure chain for proper tension and sufficient lubrication.
4. Brakes, clutch, steering and throttle for proper responsiveness.
5. Smooth operation and free play in front and rear brake levers.
6. Engine oil and coolant level.
7. Headlamp, tail lamp, brake lamp and indicator lamps for proper functioning.
8. Proper functioning of all the warning lamps in the instrument cluster.

9. Brake fluid level is above the "MIN" mark in the master cylinder.
10. Ensure the clutch free play and clutch function.



WARNING

For your personal welfare and safety, all the points mentioned above should be performed periodically. Failure to do so may affect safe operation, damage your motorcycle and could result in an accident causing serious injury or loss of life.

RUNNING IN PERIOD

The Royal Enfield motorcycle as you would be experiencing is capable of consistent high speeds. However as with any new motorcycle, a "RUNNING-IN PERIOD" procedure is essential to help in proper "Bedding-in" of the various moving parts in your motorcycle and to achieve optimum performance like gear shifting subsequently.

1. Do not exceed maximum specified pay load.
2. Warm up the engine for a few minutes at idling speed to allow engine oil to lubricate all the moving parts in the engine before riding the motorcycle.
3. Avoid full throttle operation and do not ride at constant throttle continuously. Vary the speed by 10% while riding.
4. Ride at proper speed and avoid sudden accelerations and braking.
5. Avoid riding motorcycle continuously for over an hour, it is recommended to take brief stop.

NOTE

The below table indicates the recommended engine speed in rpm for optimum performance of the engine.

Distance Covered	Max. Engine Speed
0 to 500 km	4000 rpm
501 to 2000 km	6000 rpm

STARTING

- To shift into neutral, move the motorcycle back and forth gently, while simultaneously shifting the gear. Ensure gear is in neutral position and the neutral lamp is glowing in the instrument cluster.

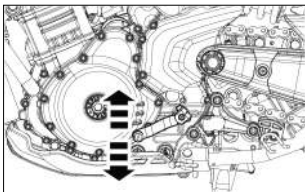

- Turn ignition key to ON position and engine kill switch on right hand side handle bar to run position.
- When both the ignition and engine kill switch is in "ON" position and after the vehicle is started, the MIL will glow for a few seconds and turns "OFF", this indicates

that all the function of the electronic fuel injection (EFI) system is functioning normally. In the event of any malfunction in the EFI system the MIL will glow continuously.

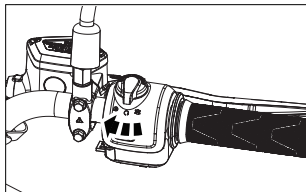

STARTING

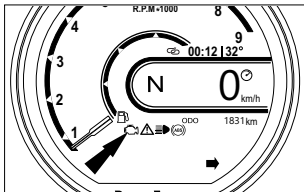

CAUTION

- In case the malfunction indicator does not turn OFF, get the motorcycle checked through a Royal Enfield Authorised Service Centre for rectification.
- Check the fuel level indicator in the cluster for adequate fuel in the fuel tank. In case the last bar is blinking continuously, it indicates low fuel level in the tank. Please re-fuel immediately.

- Disengage clutch by pulling in the clutch lever and hold it in depressed condition.

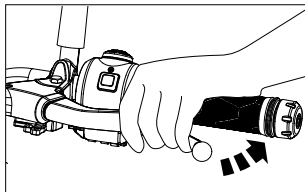

- Push and hold electric start switch until engine starts for a maximum of 5 seconds.

STARTING

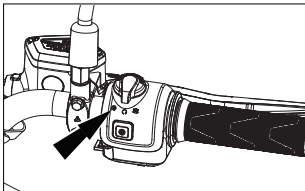

NOTE

- In case the engine does not start within 5 seconds, release starter switch and wait for about 5 seconds before attempting to start the engine again.
- In case vehicle not starting on multiple continuous attempts, please turn OFF and turn ON ignition switch and then start again.

PRECAUTIONS

- Vehicle may start with side stand condition but engine will turn-off when gear is engaged, this side stand cut-off feature is provided for rider safety ensure side stand is retracted before vehicle moving / starting.

CAUTION

- If the engine does not start. Do not hold the starter switch in depressed condition for long periods, this will cause the battery to drain below the threshold level of 10 V. Please get the motorcycle checked through a Royal Enfield Authorised Service Centre to identify and correct the reason for not starting.

STARTING

- Never accelerate as soon as the engine starts, especially in cold condition. The engine should be allowed to run in idle rpm for at least 120 seconds for the engine oil to circulate and lubricate all the internal moving parts and for the engine temperature to raise. Failure to adhere to this important information will cause serious damage to the engine internals.
- Accelerate only after the idling rpm has stabilized and it is consistent.
- If the acceleration cable is damaged, should be replace the entire RH side module cube.



WARNING

Please exercise extreme care while riding the motorcycle. Failure to do so can result in an accident causing injury to you or to other road users / passerby.

- Ensure gear in neutral position and the neutral lamp is glowing in the speedometer. To shift into neutral, move the motorcycle back and forth gently, while simultaneously shifting the gear.

CAUTION

Do not attempt to shift gears without moving the motorcycle back and forth as it will damage the gears mechanism.

- Depress and hold the clutch Lever.
- Press starter button and hold till engine starts. Do not release the button before engine starts.

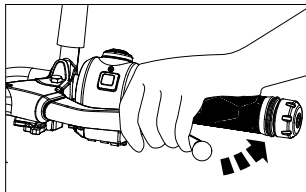

- Do not press the starter button more than 5 seconds after three successive cranking, wait for 15 to 20 seconds the battery to recover.

GEAR SHIFTING, RIDING AND STOPPING

The clutch lever must be fully depressed before attempting a gear shift. Failure to fully depress the clutch lever will cause a rough start or stalling of the engine besides causing damage to transmission parts.

- When the vehicle is in neutral position, press gear shift lever down with toe to engage 1st gear.

GEAR SHIFT PATTERN

1 -- N -- 2 -- 3 -- 4 -- 5 -- 6

Half clutch usage pattern:

To maintain smooth control at low speed (<10 km/h), It is recommended to partially engage ('slip') the clutch while applying the throttle in order to prevent the engine from stalling. When holding the clutch in this partially engaged position, the motorcycle should be in 1st gear and at low engine RPM, in order to avoid excess wear or damage to the clutch components.

- Holding the clutch in a partially engaged position at lower speeds in 2nd gear or above will require higher engine RPM in order to prevent stalling as the clutch is released. This will increase clutch 'slip' and is likely to result in premature wear of clutch components.
- After shifting from one gear to another engage the clutch gradually (Not slowly).
- Wherever possible use the vehicle in clutch fully disengaged condition only with appropriate gears, which will give good clutch life.

GEAR SHIFTING, RIDING AND STOPPING

Recommended up shift speed	
Gear change	km/h
1 st - 2 nd	20
2 nd - 3 rd	30
3 rd - 4 th	40
4 th - 5 th	60
5 th - 6 th	75

Recommended down shift speed	
Gear change	km/h
6 th - 5 th	70
5 th - 4 th	55
4 th - 3 rd	35
3 rd - 2 nd	25
2 nd - 1 st	18

CAUTION

- If the clutch lever is released abruptly and throttle opening is done insufficiently the motorcycle will have a rough start and cause the engine to stall.

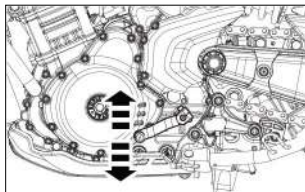

- If the acceleration is very high and clutch lever is released abruptly, it will cause motorcycle to move suddenly, which will lead to loss of control leading to an accident resulting in injury and or loss of life to rider / other road users / passed by, besides damaging the motorcycle.

GEAR SHIFTING, RIDING AND STOPPING

- Always exercise with utmost caution while releasing clutch and riding the motorcycle.
- Follow the recommended up shifting and down shifting speeds.
- Always shift gears to neutral position just before bringing the vehicle to a complete stop.
- Close throttle fully and release the clutch lever slowly ensuring the motorcycle is in neutral position and neutral lamp is glowing.

NOTE

- Always start motorcycle with the gear in neutral condition.
- Always move the motorcycle in first gear position only.
- When the engine speed decreases or while climbing a gradient or running at a reduced speed, shift to the appropriate lower gear to prevent the engine from stalling or straining to pull.
- The clutch lever must be fully depressed, throttle modulated and immediately shifted to next gear as per recommended gear shifting speeds.
- Failure to follow the above may cause a rough start or stalling or improper gear shifting of the engine besides causing damage to transmission parts.
- Stop the motorcycle in a safe place, turn OFF ignition and switch OFF engine kill switch.
- While riding on steep slopes and descending long roads it is recommended to use the brake intermittently along with Engine braking in a combination way to achieve effective braking. Engine braking is achieved by performing downshifting of the gear from the current gear to slow down the vehicle.

PARKING

PARKING MOTOR CYCLE ON CENTER STAND

- Park the motorcycle in an upright position.
- Hold handle bar firmly in a straight position.
- Lower center stand, such that, both the legs of the stand are resting on a firm ground.

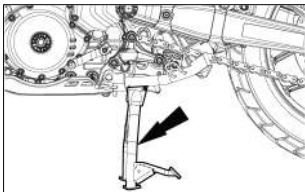

- Apply pressure on the fulcrum lever on the center stand and pull the motorcycle backward.

- Lock the steering and ensure the handle bar is locked firmly before removing the key from the ignition barrel.

PARKING MOTORCYCLE ON SIDE STAND

- Park the motorcycle in an upright position.
- Extend side stand. Tilt the motorcycle to the left side, till it is supported firmly on the ground.

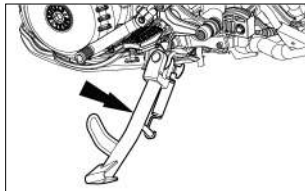

PARKING



WARNING

- Ensure both stands are fully retracted before riding the motorcycle.
- Please exercise extreme care while parking and ensure it is parked on a firm and flat surface to avoid the motorcycle from falling over and causing injury to you or to others and damage to the motorcycle parts.
- The side stand is only designed for the weight of the motorcycle. Do not sit on the motorcycle when it is resting on the side stand. The side stand or frame may become damaged and the motorcycle may fall over.

TOOLS KIT AND FIRST AID KIT

The tool kit is strapped underneath the seat.

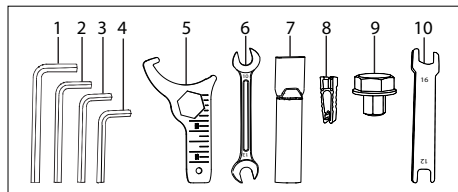

S.No	Description	Qty
1	Allen key 8 mm	1
2	Allen key 6 mm	1
3	Allen key 5 mm	1
4	Allen key 4 mm	1
5	C-Spanner and 24 Ring spanner	1
6	Double end spanner 10 x 13	1
7	Extension tube	1

8	Fuse puller	1
9	Front spindle adapter	1
10	Open end spanner 12*16	2

A first aid kit is provided with the motorcycle for any emergency requirements. Please inspect the kit regularly and replace materials upon expiry.

S.No	Description
1	Antiseptic cream 5 gms
2	Wash proof plaster 1.9 cm x 7.2 cm
3	Gauze bandage 5 cm x 2 cm
4	Sterilized Gauze Swab 5 cm x 5 cm
5	Sterilized elastic plaster 7 cm x 6 cm
6	Elastic gauze bandage 8 cm x 1 m
7	First aid kit pouch

MINOR MAINTENANCE TIPS

The following simple maintenance activities will help in maintaining your motorcycle. However for an elaborate maintenance, we recommend you to get in touch with a Royal Enfield Authorised Dealer / Service centre.

HAND LEVERS, CENTER AND SIDE STAND PIVOTS

- Clean the pivot points and ensure they are free of any dirt, grime, rust, etc.
- Lubricate the pivots.

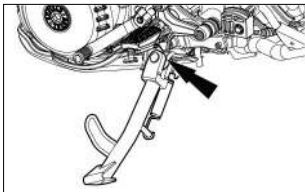

NOTE

Wipe off the excess lubricant to prevent dirt and grime from accumulating.

DRIVE CHAIN

- Spray drive chain with recommended chain cleaning solvent while simultaneously rotating rear wheel.

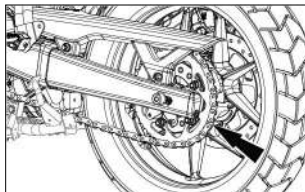

- Ensure the drive chain has been sufficiently and completely covered with the cleaning solvent. If necessary use a suitable brush to remove hard deposits from the chain.

MINOR MAINTENANCE TIPS

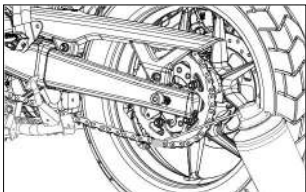

- Wait for a few minutes and clean the chain thoroughly from any dirt, grime, etc.
- Rotate rear wheel slowly and simultaneously apply recommended chain lubricant on the chain links.
- Wipe off excess chain lubricant after a few minutes with a clean cloth.

ENGINE OIL LEVEL CHECKING

- Place the vehicle on a level surface upright.
- Start the engine from cold condition, allow the engine to idle for 2 to 3 minutes and stop the engine.

- Wait 2 to 3 minutes to settle the oil and assess the sight glass. The volume added the minimum to maximum level is approximately 350 ml.
- Engine oil level should be close to "MAX" condition.

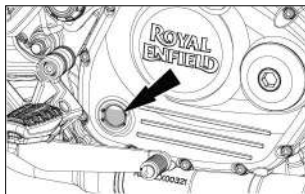

- If in case of oil level is not in above mentioned condition, then top-up the oil to "MAX" condition and repeat the procedure.
- Do not over fill above the "MAX" mark as it may affect the clutch function.

MINOR MAINTENANCE TIPS

ENGINE OIL DRAINING/STRAINER CHECK

- Ensure vehicle is in straight position on ground level.
- Engine oil should always be drained when the engine is warmed up sufficiently so that the oil drains faster.
- Remove the sump guard and 2 plugs, then clean the 2 strainers.
- Check the condition of strainers, if strainers condition OK please reuse it.

NOTE

Do not reuse the O-rings, renew all O-rings.

- Lubricate strainer and O-rings with engine oil.
- Push strainers fully into crankcases by hand before inserting the drain plugs.
- Lubricate plug O-rings with water based lubricant.
- Tighten torque of drain plugs to 13 ± 1 Nm.

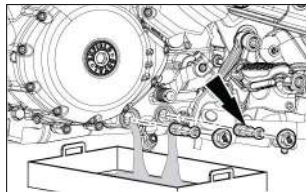

OIL FILLING DURING OIL SERVICE

- Ensure vehicle is in straight position on ground level.
- Remove the filler cap both cap and O-ring.
- Add oil to the engine, fill until the oil level reaches the maximum mark on the sight glass.
- Install the filler cap. Start the engine from cold condition and run for 1-2 minutes.
- Switch off the engine and wait 1 minute.

MINOR MAINTENANCE TIPS

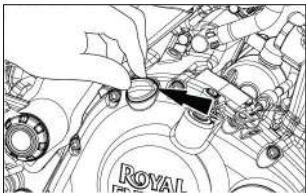

- Check that the oil level is between the minimum and maximum lines on the sight glass.
- If not, top up the oil level so that it is between the minimum and maximum lines on the sight glass
- Refill the specified fresh engine oil quantity 2.1 L approximately.

OIL FILTER REPLACEMENT

- Remove the oil filter cover with O-ring and spring.
- Remove and discard the oil filter.

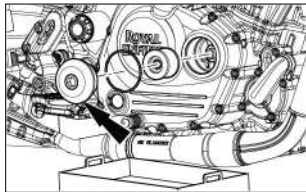

- Allow the oil to drain from the oil filter housing.
- Thoroughly clean the cover and the O-ring sealing surface.
- Install a new oil filter with new O-ring and lubricate the O-ring in the filter cover with water based lubricant.
- Install the cover and tighten to 22 ± 2 Nm, ensuring spring is retained in the cover.

MINOR MAINTENANCE TIPS

COOLANT DRAINING

- Possibly remove the sump guard.
- Remove the coolant filler cap on radiator and cap on expansion tank.

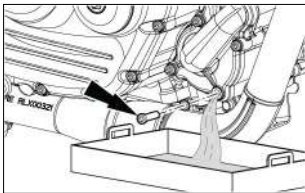

- Remove the coolant drain bolt on the water pump.
- Once drained, then replace the copper washer with a new part and tighten bolt to 11?1 Nm.
- Expansion tank is drained by disconnecting small hose to radiator then refit the hose.

COOLANT FILLING/AIR BLEEDING



WARNING

Never open a radiator cap when the engine is hot. The pressure released can make the coolant begin to boil and expand. Boiling coolant could spurt out of the filler neck or reservoir, causing severe burns.

- Ensure vehicle is in straight position on ground level.
- Remove the radiator pressure cap and fill the system with recommended coolant, up to the filler neck.

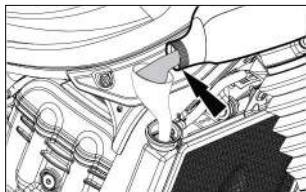

- Carry out air bleeding.

MINOR MAINTENANCE TIPS

- ★ Gently tap and squeeze both engine to radiator hoses.
- ★ Tip the bike to approximately 45-60 degree angle on the left and then the right side.
- ★ If coolant level has dropped, top back up to filler neck level.
- Repeat above procedure until the level in the filler neck no longer drops.
- Refit the radiator pressure cap ensuring it is correctly fitted & fully tightened clockwise.

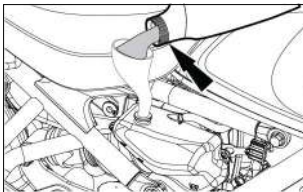

- Remove the radiator expansion tank cap and fill the tank to the upper level line.

- Replace the radiator expansion tank cap.
- Start the engine in neutral.
- Run the engine at idle for 5 minutes.
- Blip the throttle 3 or 4 times.
- Stop the engine and allow it to cool.
- Top up the coolant level in the expansion tank if required.
- Check for coolant leaks.



WARNING

Do not spill coolant. Collect coolant in a separate container and dispose it through authorized disposal agencies in your locality. Avoid skin or body contact with the coolant. Promptly wash affected area with soap and water.

NOTE

- Do not fill the coolant when a vehicle is on side stand condition.
- Coolant from Total is ready to use and does not require mixing.

MINOR MAINTENANCE TIPS

CHECKING BRAKE FLUID

Front: Check that the brake fluid reservoir is horizontal and that the fluid level is center of the window consider as a minimum level.

Rear: Check that the brake fluid reservoir is horizontal and that the fluid level is center of the window consider as a minimum level and top of the line consider as a maximum.

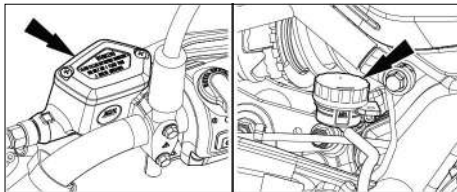

Place your motorcycle in an upright position on a firm, level surface.

CAUTION

- Brake fluid is highly corrosive and can cause damage to painted parts. Please ensure that brake fluid does not spill on any part of the motorcycle. In the event of a spill, please clean the area immediately with a soft cloth (preferably a wet cloth) to avoid damage.
- Do not mix DOT 4 & other brake fluid together.

NOTE

- Clean the filler cap before removing. Use only DOT 4 brake fluid from sealer container.
- Use only the specified brake fluid; otherwise, the rubber seals may deteriorate, causing leakage.
- Refill with the same type of brake fluid. Adding a brake fluid other than DOT 4 may result in a harmful chemical reaction.

MINOR MAINTENANCE TIPS

- Be careful that water or dust does not enter the brake fluid reservoir when refilling. Water will significantly lower the boiling point of the fluid and may result in vapor lock and dirt may clog the ABS hydraulic unit valves.



WARNING

- An insufficient brake fluid level will cause the brake system to fail.
- Old brake fluid reduces the braking effect.
- Make sure that brake fluid for the front and rear brake is changed in accordance with the periodic maintenance schedule.
- Keep brake fluid out of the reach of children.
- Do not allow brake fluid to come into contact with the skin, the eyes or clothing.

- Brake fluid is highly corrosive and can cause damage to painted parts. Ensure brake fluid does not spill on any part of the motorcycle, in the event of spill please clean the area immediately with a soft cloth to avoid damage.

INSPECTION OF TYRES AND WHEELS

- Inspect the tyres periodically for tread wear, cracks and cuts.
- Check and remove stone, splinters, nails or other particles embedded in the tyre treads.

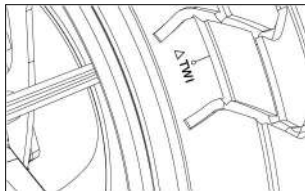

MINOR MAINTENANCE TIPS

- Periodically inspect wheels for spokes damage and wheel rim for wobbling or run out.
- Check proper seating of the tyre beading on the rim whenever the tyre is reassembled.
- Use only recommended tyres, inflated to correct air pressure.

Tyre pressure	Front	Rear
Solo	32 psi	36 psi
With Pillion	32 psi	36 psi



WARNING

- It is recommended to operate the motorcycle with correct tyre pressure as under inflated tyre may cause tyre to overheat and may result in tyre damage and may cause injury to the rider.

- It is recommended to use Royal Enfield tyre specification in case of replacement of new tyres, failure to adhere the same may result in tyre damage and may cause injury to the rider.

BRAKE PADS

- The front and rear brake pads must be checked for wear at the intervals specified in the periodic maintenance chart.

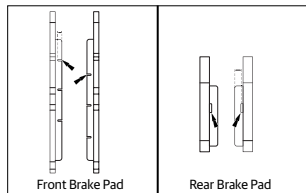

MINOR MAINTENANCE TIPS

Front/Rear : The pads need to be replaced if a brake pad is warm to the indicator.

NOTE

- Royal Enfield Motorcycles fitted with disc brakes have the optimum braking systems and are built to give a superior and safer braking performance under all conditions.
- Disc braking systems can produce a mild noise under certain riding conditions. This is absolutely normal and characteristic of the disc brake pads across the motorcycle industry. This in no way will affect the performance of the motorcycle or the braking system.
- At Royal Enfield, we have robust and rigorous testing and development protocols and adhere to global validation standards of quality and durability. We are committed to giving our customers the best possible ownership experience with our motorcycles.

FRONT WHEEL REMOVAL

- Ensure motorcycle is upright on a firm and flat surface.
- Locate a scissor jack under the engine and lift motorcycle such that the front wheel is off the ground by minimum 15 cm.

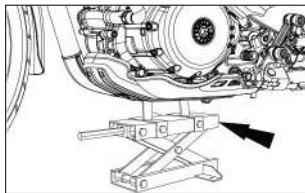

- Loosen and remove fork clamp bolt 2 Nos from RHS front fork assembly by using 6 mm Allen key available in the tool kit.

MINOR MAINTENANCE TIPS

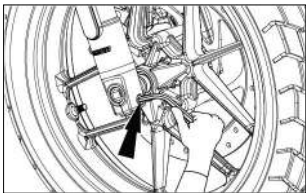

- Loosen and remove spindle bolt from RHS front fork assembly by using front spindle adapter, ring spanner and extension tube are available in the tool kit.

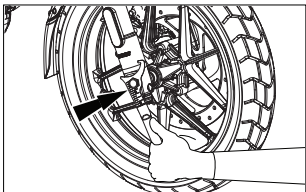

- Gently pull out the spindle from RHS by hand once fully unscrewed.
- Gently lower the wheel such that it comes out of the fork legs.
- Remove spacers from front wheel hub on both LHS and RHS.

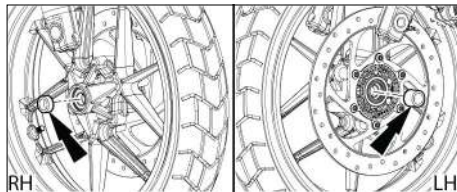

CAUTION

- Take care to secure the wheel spacers and speed sensor while removing the axle from the forks.

MINOR MAINTENANCE TIPS

- Do not press the brake lever when front wheel is removed as this will result in the brake pads coming too far out of the brake caliper.

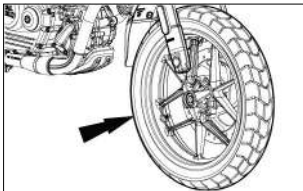

- Place a 4 mm thick wooden piece or cardboard sheet between the brake pads to avoid pads activation in the event the front brake lever is accidentally pressed.
- Take care not to damage the front brake disc or toner ring as it will affect the braking system and ABS.

FRONT WHEEL ASSEMBLY

- Remove the wooden piece/cardboard sheet placed between the brake pads.

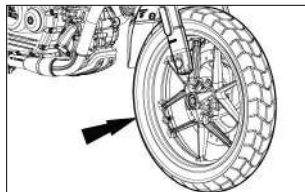

- Locate spacer to the wheel hub on both LH and RH side.
- Insert the wheel along with spacers between the fork ends. Ensure the brake disc is located between the brake pads.

MINOR MAINTENANCE TIPS

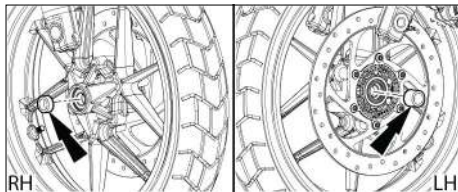

- Support the wheel at a height that the spindle can be fitted through the fork legs and wheel. Insert the spindle from the LHS and push until the threads of the spindle engage with those of the RHS fork leg then screw spindle until fully seated.
- Tighten spindle bolt firmly on RH side to a torque of 70 Nm.

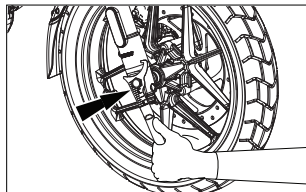

- Tighten fork clamp bolt firmly on RH side to a torque of 45 Nm.

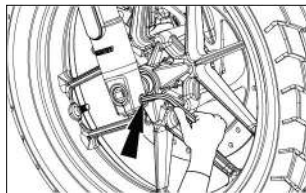

MINOR MAINTENANCE TIPS

- Rotate wheel to check for smooth rotation.
- Press brake lever and check front brake efficiency.

CAUTION

- Please exercise with utmost caution while reassembling the front wheel on the motorcycle.
- Please ensure the wheel is fitted correctly before attempting to ride the motorcycle.
- Failure to do so may result in the motorcycle not performing correctly, may lead to an accident causing injury to you / other road users and may lead to loss of life.

REAR WHEEL REMOVAL

- Ensure motorcycle is upright on a firm and flat surface.
- Apply the center stand.

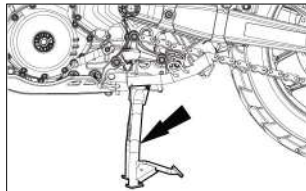

- Observe and mark the alignment indexes on both chain adjuster on left and right side swing arm.

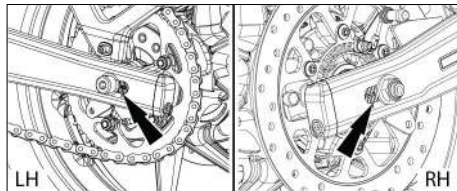

MINOR MAINTENANCE TIPS

- Loosen the lock nuts and adjuster nuts fully on the left and right side chain adjuster by using 24 mm ring spanner with extension tube available in the tool kit.
- Hold wheel spindle on left side firmly and loosen hex nut on right side.

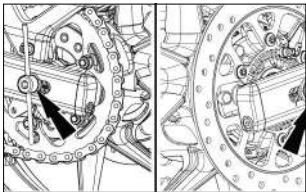

- Remove the nut and washer from the wheel spindle.

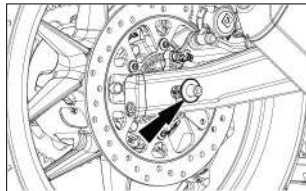

- Push rear wheel fully into the swing arm.
- Support rear wheel from bottom and pull out wheel spindle from the left side swing arm.

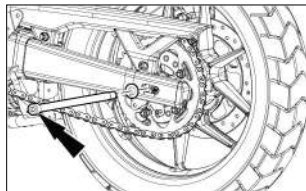

MINOR MAINTENANCE TIPS

- Release the brake hose gently and remove caliper assembly from swing arm on right side.

CAUTION

Ensure brake hose does not get damaged or kinked while removing. Support caliper assembly suitably and away from swing arm.

- Release the chain from the sprocket and ensure it does not get jammed or damaged when removing rear wheel.

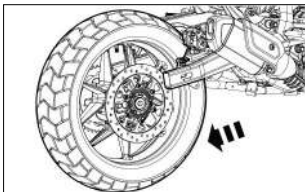

- Remove support from wheel bottom and gently slide out rear wheel from the swing arm with rear sprocket, brake disc and spacers.

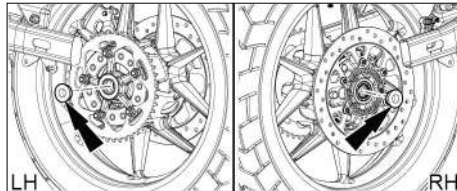

CAUTION

Do not press the rear brake pedal when the rear wheel is being removed as this will cause the brake pads to dislocate from the brake caliper.

MINOR MAINTENANCE TIPS

- Place a 4 mm thick wooden piece or cardboard sheet between the brake pads to avoid activation of brake pads if rear brake pedal is accidentally pressed.
- Do not pull up the rear brake pedal to lift or raise the motorcycle for any reason.

REAR WHEEL ASSEMBLY

- Ensure stepped spacer is located on the brake disc side, the lip of the spacer should be inserted through the bearing seal.

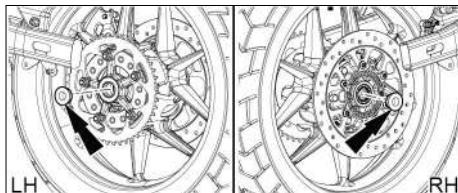

- Ensure spacer is located along the sprocket side on the wheel hub.
- Ensure that the chain adjusters are located properly inside the swing arm left and right sides.
- Locate caliper assembly on the tab along the swing arm right side.

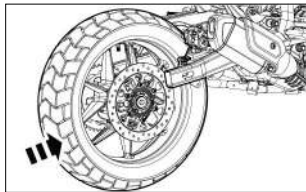

- Locate rear wheel with the sprocket to the left side ensuring the brake disc in between the brake pads on right side.

MINOR MAINTENANCE TIPS

- Lift up the rear wheel and ensure that the slots in the swing arm brake caliper bracket holes in chain adjusters and the center hole in the hub are aligned.
- Support rear wheel suitably and insert rear wheel spindle along the left side swing arm into the wheel hub.

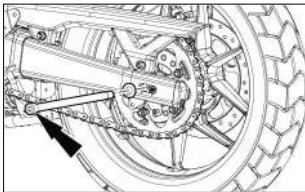

- Tab spindle gently into wheel hub slot till the threads are completely visible on the right side.
- Assemble the drive chain on the sprocket and ensure it is seated correctly.

- Check for free and smooth rotation of the rear wheel.
- Assemble washer and hex nut on wheel spindle on right side.

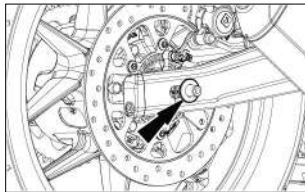

NOTE

Do not tighten hex nut fully.

- Tighten chain adjuster nuts on left and right adjuster such that the index marks are aligned correctly on both sides of the swing arm.

MINOR MAINTENANCE TIPS

- Check and ensure correct chain tension and wheel alignment.
- Hold spindle firmly on left side and tighten hex nut on right side.
- Locate the caliper assembly on swing arm right side.

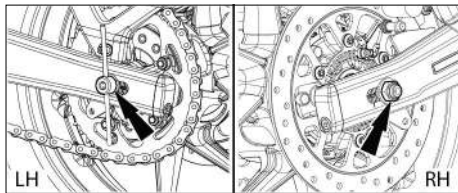

- Check rear brake for proper operating efficiency.

CAUTION

Please exercise utmost caution while reassembling the rear wheel on the motorcycle.

Please ensure the wheel is fitted correctly before attempting to ride the motorcycle.

Failure to do so will result in poor performance of motorcycle which may lead to an accident causing injury to you / other road users and may lead to loss of life.

GENERAL CLUTCH LEVER FREE PLAY

- Clutch lever free play should be set to ensure that at any position when moving from left hand (LH) to right hand (RH) there is a certain amount of free play present at all conditions.

CLUTCH CABLE FREE PLAY INSPECTION / ADJUSTMENT

1. Clutch cable free play, plays a major role in clutch life & it is recommended to adjust whenever required for good clutch life.
2. Ensure the cable fitted correctly.

MINOR MAINTENANCE TIPS

3. Steering handlebar to right hand lock position.
4. Using a 12 mm spanner, loosen the adjusting nut closest to the lifter arm fully and measuring the instrument.

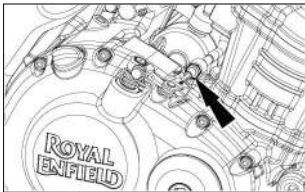

5. Adjust the position of the inner adjusting nut to provide 9- 11 mm of free play in the clutch lever ball end (from its furthest position) before engine engagement.

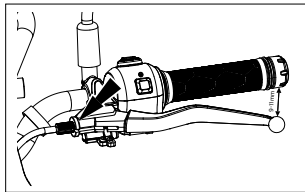

6. Pull the lever 3 times and check the gap again, adjust as per the previous point procedure if necessary.
7. Using both spanners, tighten the nut closest to the lifter arm without moving the inner nut.
8. Rotate the handlebar 5 or more times, returning to a straight position and re-check the free play in the lever.
9. Adjust as per steps 4 & 5 procedure if necessary.

MINOR MAINTENANCE TIPS

CAUTION

- If you are not comfortable to adjust free play as per stated procedure, please visit near by service centre.
- If desired free play is not achieved or there is a suspect of clutch slip- keep positive free play & reach nearest service centre.
- Adjuster nut should rest properly in the threaded region.
- Clutch free play should be checked and adjusted only when the engine is cold.
- During clutch play checking, check the clutch cable for any abnormality as it is in vehicle condition.
- If any abnormality suspected, reach nearest service centre.

DRIVE CHAIN TENSION (FREE PLAY 35 - 40 mm)

1. Park motorcycle up right on a firm and flat surface.
2. Ensure the motorcycle is in neutral position.
3. Rotate the wheel until you find a position, where the chain slackness is at it's lowest/tightest.
4. At the specified point, press the chain upwards and measure the distance to the swing arm.
5. Press the chain downwards and measure the distance to the swing arm.

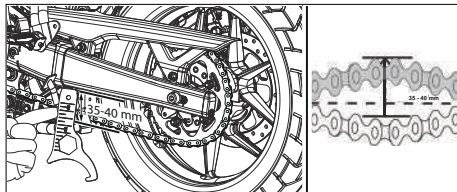

MINOR MAINTENANCE TIPS

6. The difference between values in step 4 and step 5 should be the drive chain free play is 35 to 40 mm.
7. If the drive chain free play is found to be incorrect adjust as follows:
 - (a) Loosen the rear wheel spindle.
 - (b) Push the rear wheel to the extreme front in the swing arm slot.
 - (c) Turn the adjusting Allen bolt in small increments evenly on both sides, until the specified slackness is achieved. Wheel position in the slot on both sides should always be kept equal between left and right.
 - (d) Tighten the wheel spindle torque value is 70 ± 10 Nm and tighten the adjusting Allen bolt torque value is 10 Nm. Recheck the slackness in the chain to confirm it, if it's still not within specification, repeat the adjustment procedure first three steps.



WARNING

- Chain slackness beyond the specified limit will lead to chain slippage and may also cause increased wear rates to chain and sprockets.
- Please ensure the both wheels are aligned correctly, after adjusting the chain and before tightening the rear wheel spindle nut.

MINOR MAINTENANCE TIPS

BATTERY AND MAINTENANCE

- The motorcycle is provided with 12 V - 8 Ah VRLA battery.
- The battery must be periodically checked for cleanliness and corrosion free terminals.

NOTE

The poor contact or loose fitment of battery terminals may cause ECU failure.

DISMANTLING

- Switch "OFF" the engine and remove ignition key from the key barrel.
- The battery is located underneath the seat.
- Remove the seat as per procedure.
- Disconnect battery black negative (-ve) terminal bolt by using 10 mm spanner available in the tool kit.

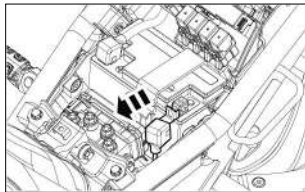

- Disconnect battery red positive (+ve) terminal bolt by using 10 mm spanner available in the tool kit.

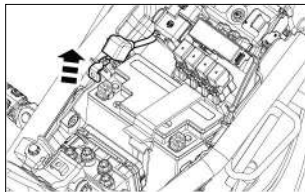

MINOR MAINTENANCE TIPS

- Pull battery strap (belt) downwards and release strap lock from battery strap bracket.

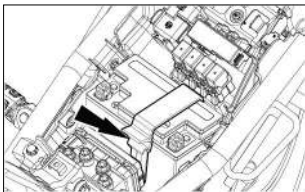

- Remove the battery from tray.

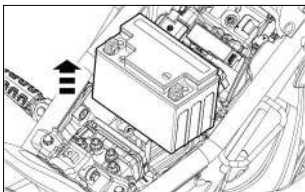

WARNING

Always disconnect the black negative (-ve) battery cable first and then the red positive (+ve) cable while removing the battery connections.

NOTE

Usage of frequency for motorcycle is very important for battery to be in good performance condition. If the motorcycle is being used very rarely or sparingly and the terminals are not disconnected the battery is bound to lose its charge and result in a dead battery.

For checking the battery voltage contact Royal Enfield Authorised Service Centre or battery service centre.

ASSEMBLY

- Assemble battery into tray.

MINOR MAINTENANCE TIPS

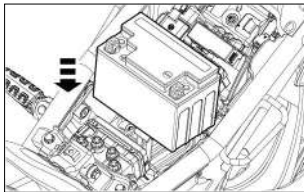

- Pull battery strap (belt) downwards to fix strap lock into battery strap bracket.

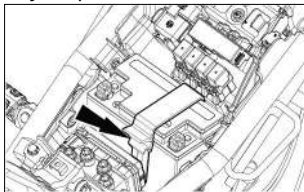

- Connect battery red positive (+ve) terminal bolt.

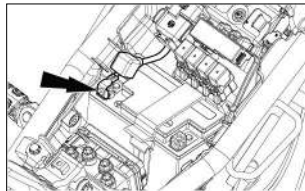

- Connect battery black negative (-ve) terminal bolt.

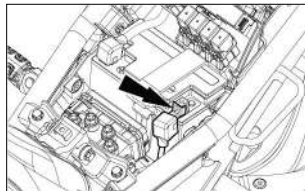

MINOR MAINTENANCE TIPS

- Refit the seat as per procedure.

CAUTION

Connect the red (+ve) positive terminal after connect black (-ve) negative terminal only.

Keep the red (+ve) positive terminal and (-ve) negative terminal cables firmly connected to the respective battery terminals. Failure to do so may result in damage to the motorcycle electrical system.

NOTE

Clean the wire terminals free from corrosion and keep the terminals coated with petroleum jelly.

CHANGING ELECTRICAL COMPONENTS

HEADLAMP DISMANTLING

- Gently loosen and remove the head light beam adjustment screw by using 4 mm Allen key.

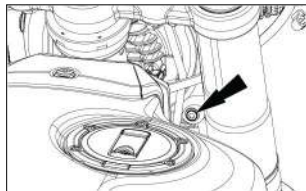

- Gently loosen and remove the LH & RH side head lamp holder Allen screws by using 4 mm Allen key.

MINOR MAINTENANCE TIPS

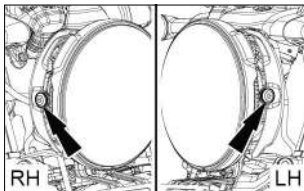

- Disconnect head lamp coupler.

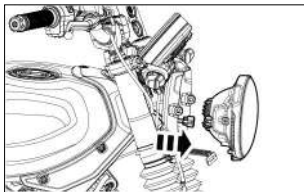

NOTE

- The headlamp has a LED lighting system. In the event of failure, the headlamp LED assembly should be replaced.
- Contact a Royal Enfield Authorised Dealer/Service Centre to replace the same.

HEADLAMP ASSEMBLY

- Connect the head lamp coupler.

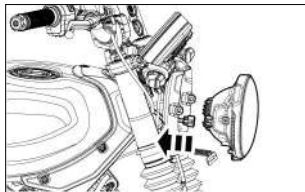

MINOR MAINTENANCE TIPS

- Tighten and refit the head lamp holder.

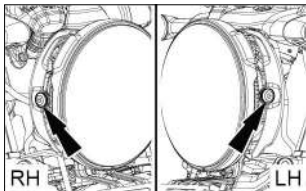

- Tighten and refit the head light beam adjustment screw.

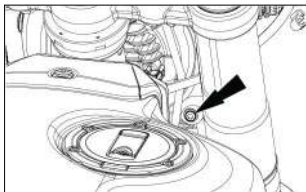

HEAD LIGHT BEAM ADJUSTMENT

- The headlight beam focus can be adjusted in vertical direction by using the adjusting screw by turning clockwise or anti clockwise direction.
- The adjusting screw is used to increase or decrease the height of the headlight beam in vertical direction only. This may be required to increase the visibility and to help prevent the other riders/vehicles passing nearby.

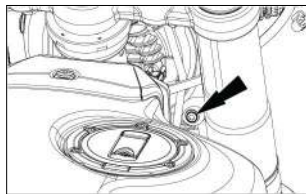

MINOR MAINTENANCE TIPS

TAIL LAMP/TRAFFICATOR & LICENSE PLATE ILLUMINATOR

- The tail lamp/trafficator (A) & license plate illuminator (B) has a LED lighting system. In the event of failure, the entire tail lamp/trafficator (A) & license plate illuminator (B) assembly should be replaced.
- Contact a Royal Enfield Authorised Dealer/Service Centre to replace the same.

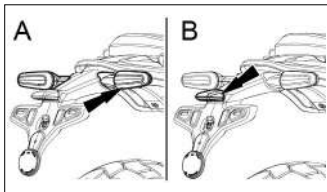

MINOR MAINTENANCE TIPS

FUSE AND FUSE CARRIER

- The fuse carrier is located underneath the seat.
- Insert ignition key and turn it clockwise.
- Remove the seat outside for opening the same.

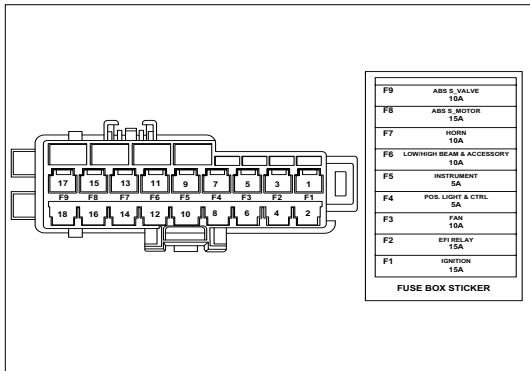
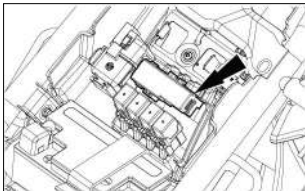

MINOR MAINTENANCE TIPS

MINI BLADE FUSE USAGE LIST

Fuse ID number	Color	Rating	Remarks
F1	Blue	15A	Ignition
F2	Blue	15A	EFI Relay
F3	Red	10A	Fan
F4	Yellow	5A	Pos.Lights & Ctrl
F5	Yellow	5A	Instruments
F6	Red	10A	Low/High Beam&Accessory
F7	Red	10A	Horn
F8	Blue	15A	ABS_Motor
F9	Red	10A	ABS S_Valve
Spare fuse list			
SF1	Yellow	5 A	Spare fuse
SF2	Red	10 A	
SF3	Blue	15 A	



WARNING

Please get the electrical system of your motorcycle checked thoroughly and get the faults corrected immediately after experiencing any fuse failure. Failure to do so may result in repeated fuse failure.

Usage of fuses other than specified rating or usage of any other conductive materials or low grade fuses will damage the complete electrical system.

Please ensure to replace a spare fuse in the holder at the earliest opportunity.

Any attempt to jumper a defective fuse gives rise to the risk of a short-circuit and fire. Always replace a defective fuse with a new fuse of the same rating.

NOTE

Make sure the ignition switch is in "OFF" position when replacing the bulbs, fuses and electrical parts.

MINOR MAINTENANCE TIPS

AIR FILTER CLEANING

- The air filter is located underneath fuel tank.
- Remove the seat as per procedure.
- Remove the fuel tank bracket bolt 1 No from frame by using 10 mm spanner available in the tool kit.

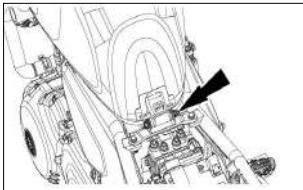

- Loosen and remove fuel tank guard top 1 No, left and right side each 2 No's button head bolt by using 4 mm Allen key available in the tool kit.

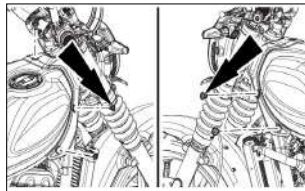

- Loosen and remove the fuel tank front end mounting bolt 2 No's using 5 mm Allen key available in the tool kit.

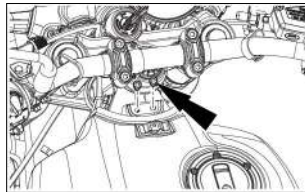

MINOR MAINTENANCE TIPS

- Disconnect the EVAP connection hose, drain hose, fuel flow hose and fuel tank sensor.

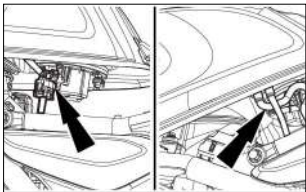

- Pull out the fuel tank outside from frame.
- Loosen and remove the air filter cover Allen screw 3 Nos by using 4 mm Allen key available in the tool kit.

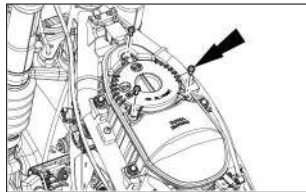

- Take out the cover from air filter box along with O-ring.

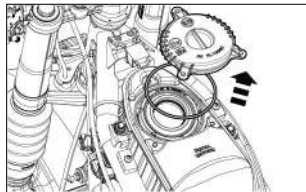

MINOR MAINTENANCE TIPS

- Pull out filter element and check for dust, dirt and oil particles inside air filter box and clean carefully.

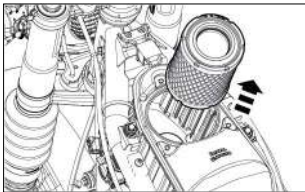

NOTE

Usage of high pressure compressed air is not recommended to clean air filter element. Fitment of air filter element is in the reverse order of removal process.

LONG TRIP PRECAUTIONS

CHECKS PRIOR TO THE COMMENCEMENT OF A LONG JOURNEY

- Service the motorcycle at Royal Enfield Authorised Service Centre.
- Ensure sufficient quantity of fuel is always available in the fuel tank for the journey planned.
- Check and correct tyre pressure if necessary.

CHECK ALL OF THESE ASPECTS BEFORE LONG RIDE

- Any loose fasteners.
- Condition of the tyres.
- Correct engine oil level and coolant level.
- Working of all lights and horn.
- Proper drive chain tension.
- Clutch cable free play.

ITEMS TO BE CARRIED

- Tools kit.
- First aid kit
- Trafficator light and fuse.
- Accelerator and clutch cables.
- Spark plug, spark plug cap and fuel hose.

REAR SUSPENSION SETTING

- Rest the motorcycle on center stand.
- Ensure the tyre pressure is at recommended specification.
- Ensure adjusters are clear of all dirt and debris before adjusting, if they have dirt or debris please clean it suitably before adjusting.

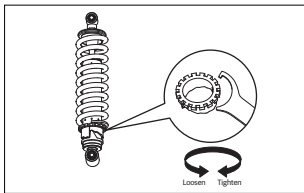

- The adjuster is a 7 step adjuster and it is kept at first notch position.

- Adjust shock preload by rotating the adjuster clockwise using C-spanner to increase the preload.
- Adjust shock preload by rotating it in anti-clockwise direction using C-spanner to decrease preload (to make it to first notch position).

NOTE

- Adjusting the suspension requires a C-spanner. We recommend using the C-spanner supplied in the vehicle tool kit. Extension tube to be used for leverage purposes.
- The best spring preload setting is achieved when it is set for the weight of the rider and that of any luggage and a passenger.

REAR SUSPENSION SETTING

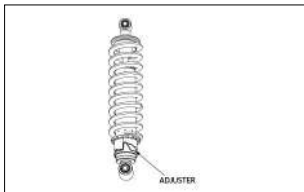

- We recommend to increase the preload and keep it at final notch for fully loaded (GVW condition), thus ensuring an ideal compromise between handling and stability.

Condition	Max reference payload	Suspension setting notch	Tyre pressure (psi)	
			Front	Rear
Unladen / One up loading / Rider only	Based on rider weight	3 rd	32	36
Laden / Two up / Rider + Pillion / Rider + Pillion + Accessories/off road condition	Up to a maximum of 191 kg payload (Inc of rider weight, pillion weight and accessories)	7 th	32	36

CLEANING PROCEDURE

PRECAUTIONS

- Remove ignition key and seal the ignition key barrel slot using adhesive tape.
- Please remove tool kit and other relevant documents if any underneath the seat before proceeding for cleaning of the motorcycle.
- The silencer tail pipe, horn and control switches should be covered suitably to prevent water entry.
- Clean the motorcycle only when the engine is in cold condition.
- Do not remove side panel while cleaning to avoid water entry.
- Brush engine area with a recommend non corrosive solvent to remove dirt or grease.
- Use low pressure water jet to clean.
- Never spray water with great force on head lamp, speedometer, flasher lights, front and rear wheel hubs, electrical connections and wires, control cables, spark plug, battery, ABS ECU, EMS ECU, side mirrors, steering stem etc.
- Do not use high pressure washers or steam jet cleaners near the seal of headstock bearing or steering stem bearing, seal of wheel bearing, brake calipers, air intakes & exhaust outlets.
- Do not apply any corrosive solvent on painted surfaces or rubber parts.
- Use lukewarm water and mild detergent on the painted components to remove dirt, etc.
- Clean motorcycle thoroughly with plain water to remove the detergent.
- Never spray water towards bottom side of instrument cluster directly to avoid water entry through breather holes.
- If possible, use compressed air and blow off water particles from the obscure areas of the motorcycle, electrical connections etc.

CLEANING PROCEDURE

- Once the motorcycle has been ridden in salty conditions (i.e. during winter in places where road salt is used) or near coastal areas it is recommended to clean your motorcycle with cold water after the ride to prevent corrosion or rust build-up. Please do not use warm water for cleaning as it may damage the motorcycle due to chemical reaction with the salt. After cleaning process once the motorcycle is completely dry it is recommended to apply anti corrosion spray on all the metal and chrome plated areas to protect the parts from corrosion.
- It is recommended not to apply the anti-corrosion spray on the brake discs.
- Do not use petrol, brake oil or other flammable liquids to clean on electronic parts.
- The parts chosen using motorcycle configurator should not be washed with soap or chemical, use only with plain water.
- No direct jet at the edges of decal, electrical parts, coupler joints, silencer tail pipe, radiator lubrication points

like steering cone kit, brake pedal, wheel bearings, chain, brake cam & swing arm bushes to be cleaned in spray mode only (not in jet mode).

AFTER CLEANING

- Ensure, the motorcycle is thoroughly dry by wiping with a clean soft lint free absorbent cloth or chamois leather.
- Remove all adhesive tapes.
- Lubricate control cables, pivots for footrest, side stand, center stand, brake and gear shifter linkages, drive chain etc., with lube oil.
- Polish the painted and plated surfaces using recommended automobile polishing wax.
- Start the engine and allow to run at an idling speed for a few minutes to warm up engine.
- Drive the motorcycle slowly, apply both the brakes intermittently to dry up the water in brake pads.
- Please clean / wipe out water spoils completely inside LH & RH side panel before keeping tools kit and other relevant documents underneath the seat.

STORAGE PRECAUTIONS

In-case your motorcycle is not going to be used for a month or more, the following precautions should be taken.

- Get the motorcycle serviced through a Royal Enfield Authorised Service Centre.
- Drain the fuel completely from the fuel tank and induction system.
- Clean drive chain thoroughly and apply Royal Enfield recommended chain lubricant.
- Wipe off excess lubricant after 5 minutes of application.
- Remove charging circuit fuse from the fuse box.
- Store the battery in a cool, dry and well ventilated place.
- Cover the silencer with suitable bags to prevent moisture entry. Set the motorcycle on its center stand.
- Apply anti rust solutions on all plated parts. Take care not to apply this solution on chrome, rubber or painted parts. Store motorcycle in a clean covered area free of moisture and dust.
- For re-use after storage, it is preferable to get the motorcycle prepared through a Royal Enfield Authorised Service Centre to ensure the motorcycle is restored to its peak operating conditions.
- If the motorcycle is not used for a month or longer, It is advised to disconnect battery terminals and remove the battery. Before refitting the battery in the motorcycle, check the battery voltage is within specification, if not, recharge it from authorized service workshop/battery dealer.

TROUBLESHOOTING

We have listed below a few basic checks in case your motorcycle is not functioning. If in case the problem is not rectified after these checks, it is necessary to get the motorcycle checked by a Royal Enfield Authorised Dealer/ Service Centre to rectify the problem and to ensure trouble free performance.

Symptom	Observations	Check for/Remedy
Engine does not start	If the ignition/Engine kill switch is in OFF position	Switch ON ignition
	If there is inadequate fuel level in fuel tank	Top up the fuel
	If the lights are dim/weak horn sound	Weak or discharged battery / problem in charging circuit Contact Authorised service center
	If fuse is blown	1. Replace the fuse with same rating 2. Contact Authorised service center if problem persists
	Connection issue with spark plug, cap, high tension cable	Reconnect spark plug, cap and high tension cable.

TROUBLESHOOTING

Symptom	Observations	Check for/Remedy
Engine starts but vehicle OFF's automatically when apply the first gear	Side stand indicator is glowing in the cluster	Side stand should be kept up right
Engine misfires & runs erratically/stops.	If any adulteration/water in fuel	Contact Authorised service center
	If the engine is too hot	Switch OFF the engine and allow it to cool down
Poor pickup	If engine RPM raises disproportionately to the vehicle speed	Adjust the clutch free play and contact Authorised service center
ABS (Anti - lock Braking System)	If the ABS lamp is continuously ON	Contact Authorised service center

ENVIRONMENT CARE

BE AN ENVIRONMENTALLY CONSCIOUS RIDER

You've ridden through some beautiful places on your Royal Enfield. Won't you like to keep them that way? Here are some tips to help you keep those places unspoilt so that others can enjoy them too:

DISPOSAL OF END OF LIFE - PARTS / VEHICLE

While your liquid waste like engine oil, coolant and other cleaning solvents need to be regularly replaced, what happens to them? Make sure they are not dumped in the soil or water bodies.

You shall store them in a container and handover to a Govt authorized recycling agent, If any or RE Service Centre.

In the case of battery, tyres, plastic parts, electric or electronic parts and oil filter shall be handed over only to an authorized recycling agent, If any or RE Service Centre.

The cleaning solvents or sprays whichever used for cleaning your bike shall be disposed in an environmentally friendly manner.

In case you want to dispose your vehicle considered as an end of life vehicle, please handover the vehicle only to an authorized / registered vehicle scrapping facility near you or contact local authorities to follow due process.

PERIODICAL MAINTENANCE

The maintenance schedule detailed here will help you to maintain your Guerrilla 450 motorcycle meticulously to get along trouble free service. The schedule provided herein is based upon an average riding conditions and indicates the km at which regular inspections, adjustments, replacements and lubrications are to be carried out. The frequency of the maintenance must be shortened depending upon the severity of the driving condition or if the motorcycle is used in a very dusty environment. Contact the nearest Royal Enfield Authorised Service Centre for expert advice and to carry out the required maintenance.

S.No	DESCRIPTION	PERIODICAL MAINTENANCE (Whichever is earlier)										
		km (x 1,000)	0.5	5	10	15	20	25	30	35	40	45
	Months	1.5	6	12	18	24	30	36	42	48	54	60
1	Engine oil	R	I	R	I	R	I	R	I	R	I	R
		Check oil level every 1000 km (or earlier as required) and top up as required										
2	Engine oil filter	R		R		R		R		R		R
3	Inlet and exhaust valve clearance			I&A		I&A				I&A		
4	Spark plug					I				R		

PERIODICAL MAINTENANCE

S.No	DESCRIPTION	PERIODICAL MAINTENANCE (Whichever is earlier)										
		0.5	5	10	15	20	25	30	35	40	45	50
	km (x 1,000)	1.5	6	12	18	24	30	36	42	48	54	60
	Months											
5	HT lead											
6	Rubber hose, air filter to throttle body											
7	Rubber hose, inlet manifold / adapter											
8	Evaporative emission equipment rubber hoses											
9	Air filter element with O-ring on cover			R		R		R		R		R
		Clean / Replace more frequently if operated in dusty condition										
10	Vent pipe under air filter box											
11	Coolant							R				
		Check coolant level in expansion tank every 1000 km (or earlier as required) and top up as required										

PERIODICAL MAINTENANCE

S.No	DESCRIPTION	PERIODICAL MAINTENANCE (Whichever is earlier)										
		0.5	5	10	15	20	25	30	35	40	45	50
	km (x 1,000)											
	Months	1.5	6	12	18	24	30	36	42	48	54	60
12	Fuel pump (under tank) mounting											
13	Fuel pump strainer							R				
14	Throttle body	Throttle body should be removed from the vehicle and cleaned with a dry microfiber cloth. Usage of throttle body cleaners or any similar solvent or alcohol based liquids for cleaning is strictly prohibited. Throttle body cleaning every 40000 km or 48 months whichever is earlier as required.										
15	Clutch cable / lever free play											
		Adjust every 1000 km (or earlier as required)										
16	Clutch lever & front brake lever pivots	L	L	L	L	L	L	L	L	L	L	L
		Lubricate every 1000 km (or earlier as required)										
17	Brake pads - front & rear											

PERIODICAL MAINTENANCE

S.No	DESCRIPTION	PERIODICAL MAINTENANCE (Whichever is earlier)										
		0.5	5	10	15	20	25	30	35	40	45	50
	km (x 1,000)	1.5	6	12	18	24	30	36	42	48	54	60
	Months											
18	Brake fluid - front & rear	I	I	I	I	R	I	I	I	R	I	I
19	Rear brake pedal pivot	L	L	L	L	L	L	L	L	L	L	L
20	Brake hose and banjo bolt - front & rear	I		I		I		I		I		I
21	Steering movement	I	I	I	I	I	I	I	I	I	I	I
22	Wheel rim run out front and rear	I	I	I	I	I	I	I	I	I	I	I
23	Rear wheel drive chain	I	I	I	I	I	I	I	I	I	I	I
		Clean, Lubricate and Adjust every 500 km (or earlier as required), or after riding in wet/dusty/muddy conditions										
24	Rear wheel cush rubbers					I				I		
25	Earth wire eyelet tightness			I		I		I		I		I

PERIODICAL MAINTENANCE

S.No	DESCRIPTION	PERIODICAL MAINTENANCE (Whichever is earlier)										
		km (x 1,000)	0.5	5	10	15	20	25	30	35	40	45
	Months	1.5	6	12	18	24	30	36	42	48	54	60
26	Battery terminals (apply petroleum jelly)	I	I	I	I	I	I	I	I	I	I	I
27	Tyre wear pattern front & rear	I	I	I	I	I	I	I	I	I	I	I
28	Side stand & centre stand pivots	L	L	L	L	L	L	L	L	L	L	L
29	Rider & pillion footrest pivots	L	L	L	L	L	L	L	L	L	L	L
30	Engine Mount, Swing arm, Front & Rear Wheel Spindle, T Stem Pinch bolts, Rear Sub Frame Mounting Bolts, Rear linkage	I	I	I	I	I	I	I	I	I	I	I

A : Adjust C : Clean I : Inspect (Clean, Adjust, Lubricate or replace if necessary) L : Lubricate R : Replace

NOTE

For maintenance after 50,000 km, please repeat the same frequency specified above, in consultation with a Royal Enfield Authorised Dealer / Service Centre.

WARRANTY TERMS AND CONDITIONS

Royal Enfield Motorcycles are manufactured by following best quality practices in respect of the material and workmanship. Royal Enfield (RE) warrants its motorcycle to be free from manufacturing and material defect under normal use subject to following conditions.

1. RE will replace or repair defective part(s) at their Dealerships and Authorised Service Centre free of charge within a period of 36 months/30,000 km from the date of sale, whichever is earlier.
2. In order to avail warranty benefits by second or subsequent owner the second/subsequent owner should inform the nearest Royal Enfield Service Centre about the purchase of the bike and shall fill in the requisite details in the form as requested by Royal Enfield.
3. The warranty shall be applicable only if all the services are availed in the respective period/kilometer ranges as per the schedule in the owner's manual from RE Authorised Dealer/Service Centre.
4. During the warranty period, RE's obligations shall be limited to repairing/replacing part(s) of the motorcycle for free only if the part(s), on examination is deemed to have a manufacturing defect. Defective part(s) which have been replaced will become the sole property of RE.
5. Consumables like oil, oil filter, fuel etc. used during warranty repair/replacement are not covered and chargeable to the customer.
6. Claims on proprietary items like tyres, spark plug, battery etc., should be taken up with the respective manufacturer or their authorised agents in the area directly by the customer. RE shall not be liable in any manner to replace them through their dealers. RE will, however, provide assistance in referring such claims on the respective manufacturer.

WARRANTY TERMS AND CONDITIONS

7. Warranty shall not apply to:

- (a) Normal ageing, deterioration or rusting of plated parts, paints coat, rubber parts, soft items, glass items, plastic parts etc.
- (b) Components like oil filter, air filter paper element, control cables, brake shoes/brake pads, clutch plates, drive chain & sprocket kit, steering ball races, electrical equipment, wiring harness etc., which are subjected to normal wear and tear.
- (c) Failures occurred due to use of non recommended grade lubricants, fuel or improper level.
- (d) Damages due to use of non recommended GMA parts, lack of proper maintenance, incorrect riding habits.
- (e) Damages to engine management system parts (like ECU, throttle body, sensors, etc.) due to tampering which affects the performance of the motorcycle.
- (f) Parts damaged due to accidents, collision, abuse etc.
- (g) Irregularities not recognised as affecting the quality or function of the motorcycle such as slight vibration, oil leakage, discoloration of exhaust pipe bend and cat region/silencer/soft or hard shock absorber etc.
- (h) Warranty is not applicable for discoloration of exhaust pipe & silencer, as it is a natural process that will happen during usage.
- (i) Defects arising from fitment of unauthorised or additional electrical loads.

WARRANTY TERMS AND CONDITIONS

- (j) Motorcycle serviced or repaired at unauthorised service centres.
 - (k) Motorcycle used for competitions/racing/stage rallying etc.
 - (l) Electrical component like bulbs, fuses etc., and electronic components failure including ECU due to repairs by arc welding.
 - (m) Motorcycle found with tampering/drilling/welding mark on any part of the frame.
 - (n) Normal maintenance operations like adjustment of brakes, cleaning fuel system, engine tune-up and other such adjustments.
 - (o) Oxidization of buffed/painted/powder coated items etc.
 - (p) Any damage resulting due to natural disaster i.e earthquake, fire and flood etc.
8. Use only Royal Enfield approved parts and accessories. Use of certain other manufacturer's performance parts will void your new motorcycle warranty.
9. RE reserves the right to finally decide on all warranty claims.
10. RE reserves the right to make changes in design of the motorcycle without any obligation to install these changes on previously supplied motorcycles.

NOTE

Ride sure with Royal Enfield's Annual maintenance contract, extended warranty and roadside assistance. To know more, visit our website or your nearest Royal Enfield store. Call us at 18002100008 to get in touch with us.

EMISSION WARRANTY

In compliance with the provisions of Rule 115(2) of the Central Motor Vehicle Rules, 1989, Royal Enfield certifies that the following warranty is applicable to those components liable to affect the emission of the gaseous pollutants in its range of motorcycle, in normal use to which it may be subjected to.

This emission warranty is valid for 30,000 km/3 years from the date of first sale whichever earlier, to the first customer and is in addition to and parallel to the warranty policy, conditions and obligations laid down in the Owner's Manual.

Royal Enfield further warrants that if on examination by its Royal Enfield Authorised Service Centre, the motorcycle fails to meet the specified emission standards, then the Authorised Service Centre shall take necessary corrective measures and shall, at its sole discretion, repair or replace free of charge components of the emission control system to meet the required emission standards.

The method/s of examination to determine the warranty conditions of the emission warranty related components will be at the sole discretion of Royal Enfield and/or our Authorised Service Centre and results of such examination will be final and binding. If on examination the warranty conditions of the part/s is/are not established, Royal Enfield will have the right to charge all, or part of the cost of such examination to the customer in addition to the cost of the components.

In case of acceptance of the component/s under Emission warranty, Royal Enfield will replace free of charge the component/s as required. However, the consumables like fuel, lubricants, solvents, etc. shall be chargeable to the customer as per actuals.

EMISSION WARRANTY

In case any of the components covered under emission warranty or the associated parts are not independently replaceable. Royal Enfield will have the sole discretion to replace either the entire assembly or parts of the assembly through suitable repairs.

Royal Enfield reserves the right to carry out necessary consequential repairs to the motorcycle or replace any part, in addition to the repair or replacement of the components covered under emission warranty. To establish compliance to in use emission standards. Such repairs/replacements will be chargeable to the customer.

All parts removed for replacement under warranty will become the property of Royal Enfield.

Royal Enfield will not be responsible for the cost of transportation of the motorcycle to the nearest Authorised Service Centre or for any loss due to non availability of the motorcycle during the period of examination and repairs by Royal Enfield and/or their Authorised Service Centre.

Royal Enfield will not be responsible for any penalties that may be charged by statutory authorities on account of failure to comply with the in-use emission standards.

The cost incurred to check emission of the motorcycle will have to be borne by the customer.

Emission warranty will be applicable irrespective of the change of ownership of the motorcycle provided all the conditions as laid down in this document are met from the date of original sale of the motorcycle.

EMISSION WARRANTY

THE WARRANTY SHALL APPLY IF THE CUSTOMER

- Observes all the important instructions and any other precautions listed in the owner's manual.
- Under all circumstances uses lubricants and fuel as recommended by Royal Enfield.
- Regularly obtains and carries out maintenance in accordance with Royal Enfield guidelines and enters the details in the log book.
- Immediately approaches the nearest RE Authorised Dealer / Service Centre upon discovery of failure to comply with the emission standard in spite of having maintained and used the motorcycle in accordance with the instructions in the owner's manual and having carried out such repairs and adjustments as may be required with a view to establish such compliance.
- Production of a valid pollution under control certificate is necessary to claim emission warranty.
- Produces the owner's manual and log book for verification details.
- Produces receipts covering maintenance of the motorcycle as specified in the owner's manual from the date of original purchase of the motorcycle.
- Produces valid certificate of Insurance and RTO Registration Certificate (R.C. Book).

EMISSION WARRANTY

THE EMISSION WARRANTY SHALL NOT APPLY IF

- A valid "Pollution under control" certificate is not produced.
- The motorcycle is not serviced by RE Authorised Dealer / Service Centre as per the service schedule described in the maintenance chart.
- The motorcycle has been subjected to abnormal use, abuse, neglect and improper maintenance or has met with an accident.
- Replacement parts not specified and approved by Royal Enfield have been used.
- The motorcycle, or parts there of, has been altered, tampered with or modified or replaced in an unauthorised manner.
- The odometer is not functioning or the odometer and / or its reading has been changed / tampered with, so that the actual distance covered cannot be readily determined.
- The motorcycle has been used for competitions, races and rallies or for the purpose of establishing records.
- On examination by Royal Enfield or its Authorised Dealer / Service Centre, if the motorcycle shows that any of the conditions stipulated in the owner's manual with regard to use and maintenance have been violated.
- The motorcycle has been run on adulterated / leaded fuel or lubricant other than those specified by Royal Enfield in the owner's manual or any other document given to the customer at the time of sale of the motorcycle.

EMISSION WARRANTY

- The emission related components are tampered with.
- All service and parts related bills and vouchers incurred during the tenure of the emission warranty is not produced.
- All maintenance activities carried out on the motorcycle during the tenure of the emission warranty are not entered in the log book.

TIPS TO BE ON THE RIGHT SIDE OF LAW

- Always get your motorcycle checked to meet the emission regulations through an authorised emission checking centre.
- Always carry a valid "Pollution Under Control" certificate with you, as and if applicable by law.

TIPS TO REDUCE POLLUTION

- Ensure that the periodical maintenance is carried out as stipulated in the owner's manual through a Royal Enfield Authorised Service Centre.
- Use only unleaded petrol from reputed fuel pumps.
- Ensure the fuel used is not adulterated.
- Use correct spark plug as recommended in the owner's manual.
- Use lubricants as per recommendations given on grade / brand in the owner's manual.

EVAPORATIVE EMISSION CONTROL SYSTEM WARRANTY

The following warranty applies to the evaporative emission control system.

Royal Enfield motors warrants the first owner and each subsequent owner, that this motorcycle is designed and built so as to conform, at the time of sale, with applicable regulations specified by the evaporative emission control system related parts fitted to this motorcycle are free from defects in materials and workmanship which may cause this motorcycle not to meet applicable regulations period of 24 months from the date of first use of the motorcycle.

The Warranty period shall begin either on the date the motorcycle is delivered to the first retail purchaser or from the first date the motorcycle is used as a demonstrator or as a display and / or trial motorcycle.

THE FOLLOWING ARE NOT COVERED BY THE EVAPORATIVE EMISSION CONTROL SYSTEM WARRANTY

1. Failures which may arise as a result of misuse, alterations, accidents or non performance of routine maintenance, as specified in the owner's manual.
2. Replacing, removing or modifying any portion of the Evaporative Emission Control System (consisting of fuel tank, fuel tank cap, canister, purge valve, throttle body, vapor hoses, fuel hoses and hose connectors) with parts not certified by Royal Enfield.
3. Loss of time, inconvenience, loss of motorcycle use or any other consequential loss or damages.
4. Any motorcycle in which the ODO meter has been tampered with or the speedo cable has been disconnected for any reason or is broken and not replaced immediately, due to which the exact distance covered cannot be determined.
5. Normal aging of parts such as fuel hoses, vapor hoses, gaskets and rubber components.

RECOMMENDATIONS FOR REQUIRED MAINTENANCE

It is recommended that the routine maintenance of the motorcycle be carried out at specified intervals and any maintenance to the evaporative emission control systems should be performed only by an Authorised Royal Enfield Service Centre and using only genuine Royal Enfield spare parts.

SERVICE/MAINTENANCE RECORD

S.No	Type of service	Schedule (Whichever is earlier)	Date	Job card No.	km	Dealer code	Brief details of service
1	1 st Free service*	500 km / 45 Days					
2	2 nd Free service*	5,000 km / 6 months					
3	3 rd Free service*	10,000 km / 12 months					
4	4 th Free service*	15,000 km / 18 months					

* Labour is free for this services alone.

NOTE

Cost of parts, lubricants, filters and other consumables are chargeable to the customer on their respective service activities. Refer the periodic maintenance chart for the respective service activities.

NOTES

Royal Enfield Recommended Lubricants



Royal Enfield Recommended add ons to Maintain your Vehicle



ROYAL ENFIELD

ROYALENFIELD.COM

Part No. RAM00971/A

Edition: July 2024